

# Operating Manual and Programming Reference

---

## **Model DS360 Ultra Low Distortion Function Generator**



1290-D Reamwood Avenue  
Sunnyvale, CA 94089 U.S.A.  
Phone: (408) 744-9040, Fax: (408) 744-9049  
email: [info@thinkSRS.com](mailto:info@thinkSRS.com) • [www.thinkSRS.com](http://www.thinkSRS.com)

Copyright © 1999, 2007, 2008, 2011, 2012, 2013 by SRS  
All Rights Reserved

---

**Certification**

Stanford Research Systems certifies that this product met its published specifications at the time of shipment. Stanford Research Systems further certifies that its calibration measurements are traceable to the United States National Institute of Standards and Technology (NIST).

---

**Warranty**

This Stanford Research Systems product is warranted against defects in materials and workmanship for a period of one (1) year from the date of shipment.

---

**Service**

For warranty service or repair, this product must be returned to a Stanford Research Systems authorized service facility. Contact Stanford Research Systems or an authorized representative before returning this product for repair.

Information in this document is subject to change without notice.

Copyright © Stanford Research Systems, Inc., 1999, 2007, 2008, 2011, 2012, 2013.  
All rights reserved.

Stanford Research Systems, Inc.  
1290-D Reamwood Avenue  
Sunnyvale, California 94089

Printed in USA

---

## Safety and Preparation for Use

### **WARNING!**

Dangerous voltages, capable of causing injury or death, are present in this instrument. Use extreme caution whenever the instrument is cover is removed. Do not remove the cover while the unit is plugged in to a live outlet.

### **Caution**

This instrument may be damaged if operated with the LINE VOLTAGE SELECTOR set for the wrong AC line voltage, or if the wrong fuse is installed.

### **Line Voltage Selection**

The DS360 operates from a 100, 120, 220 or 240 Vrms AC power source having a line frequency of 50 or 60 Hz. Before connecting the power cord to a power source, verify that the LINE VOLTAGE SELECTOR, located in the rear panel fuse holder, is set so that the correct AC input voltage is visible.

Conversion to other AC input voltages requires a change in the fuse holder voltage card position and fuse value. Disconnect the power cord, open the fuse holder cover door and rotate the fuse-pull lever to remove the fuse. Remove the small printed circuit board and select the appropriate operating voltage by orienting the printed circuit board so that the desired voltage is visible when pushed firmly into its slot. Rotate the fuse-pull lever back into its normal position and insert the correct fuse into the fuse holder.

### **Line Fuse**

Verify that the correct fuse is installed before connecting the line cord. For 100/120 VAC, use two ½ Amp fuses and for 220/240 VAC use two ¼ Amp fuses.

### **Line Cord**

The DS360 has a detachable, three-wire power cord for connection to the power source and to a protective ground. The exposed metal parts of the instrument are connected to the outlet ground to protect against electrical shock. Always use an outlet which has a properly connected protective ground.









### **Power Switch**

The power switch is located on the front panel of the unit, in the lower right hand corner. Turn on the unit by pressing the switch in.

### **Fan**

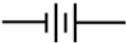
The fan in the DS360 is required to maintain proper operation. Do not block the vents in the chassis or the unit may not operate properly.

## Symbols you may find on SRS products.

Symbol	Description
	Alternating current
	Caution - risk of electric shock
	Frame or chassis terminal
	Caution - refer to accompanying documents
	Earth (ground) terminal
	Battery
	Fuse
	On (supply)
	Off (supply)

---

# Table of Contents

Safety and Preparation For Use	i
Table of Contents	iii
Table of Figures	v
Specifications	vii
Abridged Command List	xi
<b>Chapter 1 Getting Started</b>	
Front Panel Operation	1-3
Continuous Waveforms	1-4
Frequency Sweeps	1-5
Tone Bursts	1-6
<b>Chapter 2 Basics</b>	
Introduction	2-3
Front Panel Features	2-5
Rear Panel Features	2-12
<b>Chapter 3 Operation</b>	
Power On	3-3
Setting Functions	3-4
Output Configuration	3-9
Modify Functions	3-11
Instrument Setup	3-18
Troubleshooting	3-21
<b>Chapter 4 Programming</b>	
Index of Commands	4-2
Introduction	4-5
Command Syntax	4-8
Function Output Commands	4-9
Modify Function Commands	4-12
Setup Control Commands	4-15
Status Reporting Commands	4-16
Hardware Test and Calibration Commands	4-17
Status Byte Definition	4-19
Example Programs	4-21
<b>Chapter 5 Testing</b>	
Getting Ready	5-3
Front Panel Test	5-7
Self Test	5-8
Frequency Test	5-9
Amplitude Test	5-10
Harmonic Distortion	5-13
Waveform Test	5-15
Sweep Test	5-17

Burst Test	5-18
DC Offset Test	5-19
Output Impedance Test	5-21
DS360 Performance Test Record	5-23

## Chapter 6 Circuitry

Overview	6-3
Digital Board Description	6-3
Analog Board Description	6-6
Front Panel Description	6-9
Programmable Resistor Board Description	6-9
Digital Board Parts List	6-11
Analog Board Parts List	6-15
Front Panel Parts List	6-27
Distortion Filter Parts List	6-31
Miscellaneous and Chassis Parts List	6-32
Digital Board Schematics	DIG-1 to DIG-7
Analog Board Schematics	ANA-1 to ANA-7
Front Panel Schematics	FP-1 to FP-2
Programmable Resistor Board Schematics	PROGR1

## Table of Figures

Figure 2-1 Block Diagram	2-4
Figure 2-2 Front Panel	2-5
Figure 2-3 Keypad	2-6
Figure 2-4 Outputs	2-8
Figure 2-5 Indicators	2-9
Figure 2-6 Display	2-10
Figure 2-7 Rear Panel	2-12
Figure 2-8 Rear Outputs	2-13
Figure 5-1 Distortion Filter	5-5





# Specifications

## Waveforms

Sine	Frequency	0.01 Hz to 200.000 kHz	
	THD 1 V <sub>RMS</sub> Unbalanced, 2 V <sub>RMS</sub> Balanced		
	<u>Frequency</u>	<u>Typical</u>	<u>Maximum</u>
	0.01 Hz - 5.0 kHz	< -110 dB	-106 dB
	5.0 kHz - 20.0 kHz	< -104 dB	-100 dB
	20.0 kHz - 40.0 kHz	< -100 dB	-96 dB
	40.0 kHz - 100.0 kHz	< -90 dB	-85 dB
	100.0 kHz - 200.0 kHz	< -76 dB	-68 dB
	THD 10 V <sub>RMS</sub> Unbalanced, 20 V <sub>RMS</sub> Balanced		
	<u>Frequency</u>	<u>Typical</u>	<u>Maximum</u>
	0.01 Hz - 5.0 kHz	< -109 dB	-105 dB
	5.0 kHz - 20.0 kHz	< -103 dB	-99 dB
	20.0 kHz - 40.0 kHz	< -98 dB	-93 dB
	40.0 kHz - 100.0 kHz	< -88 dB	-83 dB
	100.0 kHz - 200.0 kHz	< -76 dB	-68 dB
Square	Frequency	0.01 Hz to 200 kHz	
	Rise Time	1.3 μs	
	Even Harmonics	< -60dBc (to 20 kHz)	
White Noise	Bandwidth	DC to 200 kHz	
	Flatness	< 1.0 dB pk-pk, 1 Hz to 100 kHz	
	Crest Factor	11 dB	
Pink Noise	Bandwidth	10 Hz to 200 kHz	
	Flatness	< 3.0 dB pk-pk, 20 Hz - 20 kHz (measured using 1/3 octave analysis)	
	Crest Factor	12 dB	
Bandwidth Limited Noise	Bandwidth	100 Hz, 200 Hz, 400 Hz, 800 Hz, 1.6 kHz, 3.2 kHz, 6.4 kHz, 12.8 kHz, 25.6 kHz, 51.2 kHz, 102.4 kHz	
	Center Frequency	0 Hz to 200.0 kHz, 200 Hz increments	
	Flatness (in band)	< 1.0 dB pk-pk	
	Crest Factor	Base Band (0 Hz Center Freq)	12 dB
		Non Base Band	15 dB

## viii Specifications

---

Two-Tone	Type	Sine-Sine, Sine-Square	
	Sine Frequency	0.01 Hz to 200.000 kHz	
	Square Frequency	0.1 Hz to 5.0 kHz	
	Square Resolution	2 digits	
	SFDR	>90 dB	
Sine or Square Burst	ON Cycles	1/2, 1 to 65534 cycles	
	Repetition Rate	1 to 65535 cycles	
	Triggering	Internal, External, Single, Externally Gated	
	OFF Level	0.0 % - 100.0 % (of ON Level)	
	OFF Resolution	0.1 %	
	Max OFF Attenuation	1 kHz	-90 dBc
	10 kHz	-70 dBc	
	100 kHz	-50 dBc	
White or Pink Noise Bursts	ON Time	10 $\mu$ s - 599.9s	
	Repetition Time	20 $\mu$ s - 600s	
	Triggering	Internal, External, Single, Externally Gated	
	OFF Level	0.0% - 100.0% (of ON Level)	
	Resolution	0.1%	
Sine or Square Sweeps	Type	Linear or Logarithmic	
	Range	0.01 Hz to 200.000 kHz	
	Rate	0.1 Hz to 3.1 kHz	
	Resolution	2 digits	
	Flatness	$\pm 0.1$ dB (1%)	

### Frequency

Resolution (unless otherwise specified)	6 digits or 1 mHz, whichever is larger
Accuracy	25 ppm (0.0025%) + 4 mHz from 20° to 40° C

### Amplitude

Unbalanced Output (+ output only)*	50 $\Omega$ Load	5.0 $\mu$ Vpp - 14.4 Vpp
	600 $\Omega$ Load	5.0 $\mu$ Vpp - 20.0 Vpp
	Hi-Z Load	10.0 $\mu$ Vpp - 40.0 Vpp
Balanced Outputs	50 $\Omega$ Load	10 $\mu$ Vpp - 28.8 Vpp
	150 $\Omega$ Load	10 $\mu$ Vpp - 28.8 Vpp
	600 $\Omega$ Load	10 $\mu$ Vpp - 40.0 Vpp
	Hi-Z Load	20 $\mu$ Vpp - 80.0 Vpp
Resolution	V <sub>PP</sub> OR V <sub>RMS</sub> dBm or dBV	4 digits or 1 $\mu$ V, whichever is greater 0.1dB
Accuracy	Sine, Square, 2-Tone	$\pm 0.1$ dB (1%)
	White Noise	$\pm 0.175$ dB (2%)
	Pink Noise	$\pm 0.35$ dB (4%)

\* - output amplitude is specified only in balanced mode.

**Noise**

Broadband Noise (for a 1 kHz sine wave into a high impedance).

40 V <sub>pp</sub> - 1.26 V <sub>pp</sub>	<150 nV $\sqrt{\text{Hz}}$
1.26 V <sub>pp</sub> - 126 mV <sub>pp</sub>	<15 nV $\sqrt{\text{Hz}}$
126 mV <sub>pp</sub> - 12.6 mV <sub>pp</sub>	<7.5 nV $\sqrt{\text{Hz}}$
<12.6 mV <sub>pp</sub>	<4 nV $\sqrt{\text{Hz}}$

(Note: 4 nV $\sqrt{\text{Hz}}$  is the measurement floor.)

**Offset**

Unbalanced Output	50 $\Omega$ Load	0 - $\pm$ 7.4 V <sub>DC</sub>
	600 $\Omega$ Load	0 - $\pm$ 10.0 V <sub>DC</sub>
	Hi-Z Load	0 - $\pm$ 20.0 V <sub>DC</sub>
Balanced Output		Not Active
Resolution		3 digits
Accuracy	1% of (V <sub>pp</sub> /2+Offset) + Residual Offset (Offset accuracy applies to + Output)	
Residual Offset		
	(for all except pink noise)	
	25 mV	for V <sub>pp</sub> /2+Offset > 0.63V
	2.5 mV	for 0.63V > V <sub>pp</sub> /2+Offset > 0.063V
	250 $\mu$ V	for 63 mV > V <sub>pp</sub> /2+Offset > 6.3 mV
	50 $\mu$ V	for V <sub>pp</sub> /2+Offset < 6.3 mV
	(for pink noise)	
	200 mV	for V <sub>pp</sub> /2+Offset > 0.63V
	20 mV	for 0.63V > V <sub>pp</sub> /2+Offset > 0.063V
	2 mV	for 63 mV > V <sub>pp</sub> /2+Offset > 6.3 mV
	200 $\mu$ V	for V <sub>pp</sub> /2+Offset < 6.3 mV

**Outputs**

Configuration		Balanced and Unbalanced
Connectors		Floating BNCs, banana plugs and XLR Jack
Source Impedance	Balanced	50 $\Omega$ $\pm$ 3% 150 $\Omega$ $\pm$ 2% 600 $\Omega$ $\pm$ 1% Hi-Z (50 $\Omega$ $\pm$ 3%)
	Unbalanced	50 $\Omega$ $\pm$ 3% 600 $\Omega$ $\pm$ 1% Hi-Z (25 $\Omega$ $\pm$ 1 $\Omega$ )
Maximum Floating Voltage		$\pm$ 40 V <sub>DC</sub>

**Other Outputs**

Sync	TTL squarewave (same frequency and phase as output)
Burst Out	TTL pulse marks burst (TTL high for ON time)
Trigger/Gate In	TTL pulse starts sweep or burst. TTL hi activates gated burst.
Sweep	TTL pulse marks beginning of sweep

**General**

Computer Interface	GPIB and RS-232 standard. All instrument functions can be controlled over the interfaces.
Size	17"W x 3.5"H x 16.25"D
Weight	17 lbs.
Warranty	One year parts and labor on any defects in material or workmanship.

# Abridged Command List

## Syntax

Commands which have a question mark in parentheses (?) after the mnemonic may be queried.

Commands that have a question mark without parentheses '?' may **only** be queried. Commands without a question mark **may not** be queried. Optional parameters are enclosed by { }.

## Variables

i, j, k, n	integers
x	real numbers

## Function Output Control Commands

FUNC (?) i	4-9	0=sin, 1=sqr, 2=wht noise, 3=pink noise, 4=2Tone.
FREQ (?) x	4-9	Sets Output Freq to x.
AMPL (?) x	4-9	Sets Ampl to x; must include VP, VR, dB, dV or dm.
OFFS (?) x	4-9	Sets Output Offset to x.
OUTE (?) i	4-9	Output Enable (i=1), Disable (i=0).
OUTM (?) i	4-9	Output Mode 0=unbal, 1=bal.
TERM (?) i	4-10	Source Impedance 0=50Ω, 1=150Ω, 2=600Ω, 3=HiZ.
RELA (?) i	4-10	Sets Relative Amplitude Mode ON (i=1) or OFF (i=0).
STPE (?) i	4-10	Freq Step Enable (i=1) Disable (i=0).
FSTP (?) x	4-10	Sets Freq Step to x.
TTAA (?) x	4-10	Sets Tone A amp to x; must include VP, VR, dB, dV or dm.
TTBA (?) x	4-11	Sets Tone B amp to x; must include VP, VR, dB, dV or dm.
TTAF (?) x	4-11	Sets Tone A frequency to x.
TTBF (?) x	4-11	Sets Tone B frequency to x.
TTMD (?) i	4-11	Sets 2-Tone Mode to sine (i=0) or square (i=1).

## Modify Function Commands

*TRG	4-14	Triggers a single sweep or burst.
MENA (?) i	4-14	Modify Function Enable (i=1) or Disable (i=0).
MTYP (?) i	4-14	Sets the modify function type to Lin Swp, Log Swp, Burst, BWNoise for i=0,1,2,3.
TSRC (?) i	4-14	Sets the trigger source to Int, Ext, Single or Gate for i=0,1,2,3.
STFR (?) x	4-14	Sets Sweep Start Frequency to x.
SPFR (?) x	4-14	Sets Sweep Stop Frequency to x.
RATE (?) x	4-14	Sets Sweep Rate to x.
BCNT (?) x	4-15	Sets Burst Count to x (i=.5, 1-65534).
RCNT (?) i	4-15	Sets Burst Rate to i (i=1-65535).
DPTH (?) x	4-15	Sets Burst Depth to x; must include DB or PR (%).
NBCT (?) x	4-15	Sets Noise Burst Count to x.
NRCT (?) x	4-15	Sets Noise Rate Count to x.
BNDW (?) x	4-16	Sets Noise BW to 100, 200, 400, 1.6k, 3.2k, 6.4k, 12.8k, 25.6k, 51.2k, 102.4k.
CENF (?) i	4-16	Sets BW Noise Center Frequency to i.

**Setup Control Commands**

*IDN?	4-17	Returns the DS360 device identification string.
*RCL i	4-17	Recalls stored setting number i (0 to 9).
*SAV i	4-17	Saves the current instrument setting as setting number i (1 to 9).
KEYS (?) i	4-17	Simulates the pressing of a front panel key.

**Status Reporting Commands**

*CLS	4-18	Clears all status registers.
*ESE (?) i	4-18	Sets/Reads the Standard Event Status Byte Enable register.
*ESR? {i}	4-18	Reads the value of the Standard Event Status register {or bit i only}.
*PSC (?) i	4-18	Sets the value of the power on status clear bit.
*SRE (?) i	4-18	Sets/Reads the Serial Poll Enable register.
*STB? {i}	4-18	Reads the value of the Serial Poll Byte {or bit i only}.
DENA (?) i	4-18	Sets/Reads the value of the DDS enable register.
STAT? {i}	4-18	Reads the value of the DDS register {or bit i only}.

**Hardware Test and Calibration Commands**

*TST?	4-19	Starts self test and returns status when done.
\$FCL	4-19	Recalls the factory calibration bytes.
\$FIL (?) n	4-19	Sets the State variable Filter to the n-th filter.
\$NOF (?) n	4-19	Sets the filter mode to n (0,1 or 2).
\$PRE (?) n	4-19	Sets the DS360 pre-amplifier attenuators to range n (0 to 31).
\$PST (?) n	4-20	Sets the DS360 post-amplifier attenuators to range n (0 to 3).
\$WRD (?) j,k	4-20	Sets the value of calibration word j to k.

## Chapter 1

# Getting Started

These examples are designed to acquaint the first time user with the DS360 Ultra Low Distortion Function Generator. The DS360 is a flexible generator, capable of producing continuous and modified waveforms of exceptionally low noise and distortion, and high frequency accuracy and resolution. The DS360 is also relatively easy to use; the following examples will lead you step-by-step through some typical uses.

These examples require an oscilloscope to observe the output waveforms.

## In this Chapter

---

<b>Front Panel Operation</b>	<b>1-3</b>
Keypad	1-3
Knob	1-3
<b>Continuous Waveforms</b>	<b>1-4</b>
<b>Frequency Sweeps</b>	<b>1-5</b>
<b>Tone Bursts</b>	<b>1-6</b>





## Front Panel Operation

Parameters are set in the DS360 using the front panel keypad or the spin knob. Most parameters can be set directly from the keypad, although it is often more convenient to use the spin knob. Keys are referenced by brackets like this: [Key].

### Keypad

Use the up and down arrow keys [^], [v] to change between functions. To set a parameter, press the key with the desired parameter on it, ([FREQ] for example, to set the frequency). The current value will be displayed. Most parameters are labeled on the key itself; other parameters are labeled above the key in gray. To display these values, first press the [SHIFT] key, then the desired key ([SHIFT] [TRIG SRC] to set the trigger source). To change the value, press the appropriate numeric keys, followed by the correct units key. If the value has no particular units, any of the units keys may be used. If an error is made, press the [CLR] key to return to the current value. If the value entered is outside the allowable limits the DS360 will beep and display an error message.

### Knob

The spin knob can be used to modify most parameters. Display the current value as described for the keypad and turn the knob to increment or decrement the parameter. The decade that is being incremented (or decremented) will flash. To change the decade that is being modified, use the left and right cursor keys [< ], [ > ].

## Continuous Waveforms

This section describes how to set up different continuous waveforms, like sinewaves, squarewave or noise. Connect the PLUS (+) output to an oscilloscope to observe the waveforms.

<p>1. Turn the unit on while holding down [CLR]. Wait until the power-on tests are completed.</p>	<p>When the power is turned on with the [CLR] key depressed, the unit returns to its default settings. This places the unit in a known state.</p>
<p>2. Press the [AMPL] key. Press [1][Vpp].</p> <p>Press the [FREQ] key. Press [2][kHz].</p> <p>(Or turn the spin knob until the frequency reads 2.00 kHz)</p>	<p>Set the DS360 for a 1 Vpp, 2 kHz sinewave.</p> <p>The oscilloscope should show a 2 kHz sinewave with a 1 Vpp amplitude.</p>
<p>3. Press the left cursor [&lt;] key several times until the kHz position is flashing. Turn the spin knob until the frequency reads 10.0000 kHz.</p> <p>Press the function down [v] key once.</p> <p>Press the [OFFSET] key. Press [1][VDC].</p>	<p>Set the DS360 for a 1 Vpp, 10 kHz, squarewave.</p> <p>The oscilloscope should show a 10 kHz, 1 Vpp squarewave.</p> <p>A 1 VDC offset should be added to the waveform.</p>
<p>4. Press the function down [v] key once.</p> <p>Press the [OFFSET] key. Press [0][VDC].</p> <p>Press the [AMPL] key. Press [1][Vrms].</p>	<p>Set the DS360 for 1 Vrms white noise with no offset.</p> <p>The oscilloscope should show a noisy waveform of about 7 Vpp.</p>

## Frequency Sweeps

This section describes how to set up a linear or logarithmic frequency sweep. The DS360 can sweep the output frequency of sine and square waves over any range of allowable frequencies. There are no restrictions on minimum or maximum sweep span. The sweep rate may range from 0.1Hz (10 s) to 3.1kHz (0.32 ms). Sweeps can be triggered from the internal rate generator, an external rate, the front panel or over the computer interface. The DS360 has a TTL sweep signal BNC on the rear panel that marks the beginning of a sweep. Connect the SWEEP OUT BNC on the rear panel of the DS360 to the second channel of the oscilloscope and set it to 2 V/div. The oscilloscope should be set to 0.2 ms/div and to trigger on the rising edge of this signal.

1. Press [RCL][0].	This places the DS360 in its default state.
2. Press the modify function down [v] key once.  Press the [ON/OFF] key in the MODIFY FUNC area.	Set DS360 for a logarithmic, 1kHz sweep of a sinewave.  The oscilloscope should show two periods of a 1 ms long log sweep.
3. Press the modify function up [^] key once.  Press the [RATE][2][kHz] keys.  Press the [START][1][0][0][Hz] keys.  Press the [STOP][1][0][kHz] keys.	Set the DS360 for a 2kHz linear sweep, with a start frequency of 100 Hz and a stop frequency of 10 kHz.  The oscilloscope should show 4 periods of a 0.5 ms long linear sweep.
4. Press the function down [v] key.	Change the output wave form to a square wave.  The oscilloscope should show the same frequency sweep of a squarewave.

## Tone Bursts

This section describes how to set up tone bursts. The DS360 can produce a tone burst of between 1 and 65534 cycles of sine or square waves with a repetition rate of between 1 and 65535 cycles. It can also produce bursts of noise. Bursts are generated by synchronously gating the output at zero crossings. The “on” level of a burst may be any allowable output voltage; the “off” level can be set between 0 and 100% of the “on” level in 0.1% increments. Bursts can be triggered from the internal rate generator, an external rate, the front panel or over the computer interface. They can also be gated from an external source. The DS360 has a TTL burst signal BNC on the rear panel that is high for the duration of the on level of a burst and low otherwise. Connect the BURST OUT BNC on the rear panel of the DS360 to the second channel of the oscilloscope and set it to 2 V/div. The oscilloscope should be set to 1 ms/div and to trigger on the rising edge of this signal.

1. Press [RCL][0].	This places the DS360 in its default state.
2. Press the modify function down [v] key twice.  Press the [RATE] key, then [8][units key].  Press the [SHIFT][RATE] keys, then [3][units key]  Press the [SHIFT][DEPTH] keys, then [1][0][%].	Set the DS360 to generate a 3 cycle burst, repeating every 8 cycles, with a 10% off level.  Any of the 4 units keys can be used.
3. Press the modify function [ON/OFF] key.	The oscilloscope should show an 8 cycle burst, with 3 on cycles and 5 off cycles at 10% of the “on” level.
4. Press the [SHIFT][DEPTH] keys, then [0][%].	Set the DS360 to 0% “off” level.  Observe that the “off” level is now totally flat.
5. Press the [RATE] key, then [1][2][units key].	Observe that repetition rate is 12 cycles.
6. Press the [SHIFT][RATE] keys, then [5][units key].	Observe that the “on” time is now 5 cycles.
7. Press the [FREQ] key, then [4][kHz] key.	Observe that the frequency changed, however the relative “on” and “off” times haven’t changed.

## Chapter 2

# Basics

### In this Chapter

---

<b>Introduction</b>	<b>2-3</b>
Traditional Function Generators	2-3
DS360 Function Generator	2-3
<b>Front Panel Features</b>	<b>2-5</b>
Power Switch	2-5
Reset	2-5
Spin Knob	2-5
Keypad	2-6
Function Output	2-8
Auxiliary Outputs	2-8
Indicators	2-9
Display	2-11
<b>Rear Panel Features</b>	<b>2-12</b>
Power Entry Module	2-12
Auxiliary Outputs	2-13
Computer Interfaces	2-13



# Introduction to Precision Waveform Synthesis

The DS360 uses Direct Digital Synthesis and analog signal processing to generate an extremely pure sine wave with extraordinary frequency resolution and stability. Traditional function generators typically use one of several methods to generate sine waves, each having one or more major limitations.

## Traditional Generators

Frequency synthesized function generators typically use a phase-locked loop (PLL) to lock to a stable reference, and use wave shaping circuits to produce the desired function. This solution often has limited frequency resolution. Typically frequency resolution is limited to about  $1:10^6$  (some advanced PLL circuits have much higher resolution). Distortion performance is limited due to the wave shaping circuits, often to as low as -40dB.

Arbitrary function generators eliminate the need for wave-shaping circuitry. Normally a PLL is used to create a variable clock that increments an address counter. This counter addresses memory location in a waveform RAM that produces data for a DAC. This waveform RAM can be filled with any data, to create “arbitrary” waveforms, as well as sines, squares or other common waveforms. Since this is a sampled data system, it requires an anti-imaging filter to create an accurate waveform. Sampling theory states that a waveform can be accurately reproduced, as long as it is sampled more than twice as fast as its highest frequency component. Since arbitrary function generators vary their clock frequency, they must also modify their output anti-imaging filter.

Direct digital synthesis, a relatively new technique, overcomes many of these problems. DDS works by generating addresses to a waveform RAM to produce data for a DAC. Unlike PLL based techniques, the clock is a fixed frequency reference. Instead of using a counter to generate addresses, an adder is used. On each clock cycle, the contents of a Phase Increment Register is added to the contents of the Phase Accumulator. The output of the Phase Accumulator is the address to the waveform RAM. By changing the value of the Phase Increment, the number of cycles required to step through the entire waveform RAM changes, thus changing the output frequency. Since a fixed frequency clock is used, only one anti-imaging filter is required. This technique features excellent frequency resolution, as good as  $1:10^{14}$  and reasonable distortion performance, down to -70dB.

Low distortion oscillators normally use some variety of R-C circuit in a Wein Bridge configuration to generate a pure, low distortion sine wave. This solution suffers from poor frequency accuracy, resolution and stability, due to component aging and drift. Frequency stability and accuracy for these oscillators is normally measured in 100's to 1000's of PPM. Frequency resolution is typically between 0.1% to 1%. This technique features excellent distortion performance, as low as -100 dB or better.

## DDS with Advanced Signal Processing

A block diagram for the DS360 is shown in Figure 1. The DS360 utilizes direct digital synthesis to generate its basic waveform. A Motorola DSP56002 advanced 24 bit digital signal processor (DSP) acts as the phase accumulator and contains the internal waveform RAM. The DSP chip gives the DS360 exceptional flexibility for generation of different waveforms. A 32.333 MHz, 25 PPM crystal provides all clocking information for the DS360, giving it exceptional frequency stability.

The DSP waveform RAM feeds an ultra low distortion 20 bit DAC, which is followed by a 7<sup>th</sup> order Cauer anti-imaging filter to accurately reconstruct the sampled waveforms. For sinewave generation, this is followed by a distortion reduction filter, that removes nearly all of the remaining distortion components of the waveform. The output of this filter passes through the fine amplitude control and to the low distortion balanced / unbalanced power amplifier. The power amplifier is capable of generating a 40 V<sub>pp</sub> sinewave, with about -100dB of distortion in the unbalanced configuration and superior performance at lower amplitudes. Finally the signal passes through output attenuators, capable of 0, -20, -40 or -60 dB of attenuation.

Other waveforms follow slightly different paths. White noise skips the distortion reduction filters, while pink noise adds the pink noise filter. Squarewaves and the waveform sync signal are generated by discriminating the function with a high speed comparator. Burst signals are generated by passing any of the waveforms through the burst DACs.

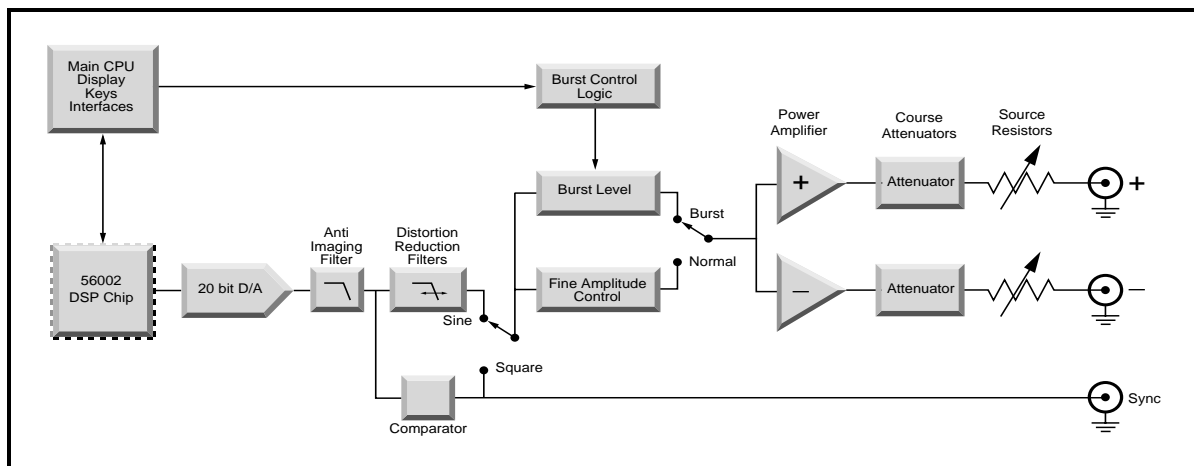

Figure 2-1 DS360 Block Diagram



# Front Panel Features

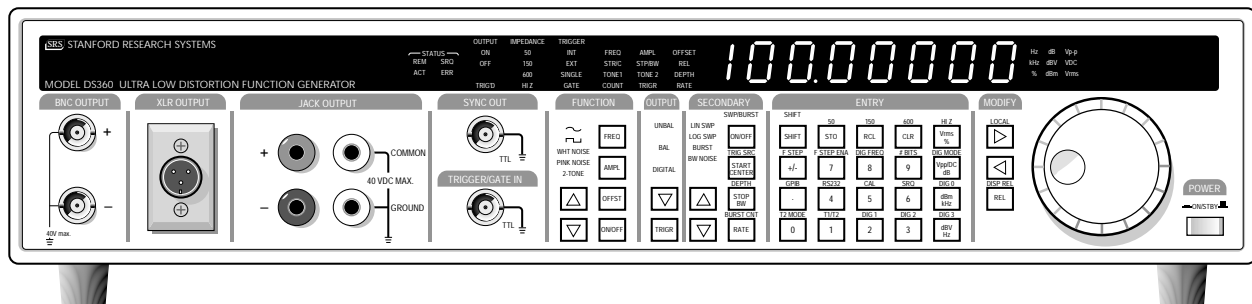

Figure 2-2 Front Panel

## Power Switch

The power for the DS360 is turned on by depressing the power button. After turning the power on the LED display will display the units serial number for about 2 seconds, perform the internal self tests and begin operation.

## Caution

This instrument may be damaged if operated with the LINE VOLTAGE SELECTOR set for the wrong AC line voltage or if the wrong fuse is installed.

## Reset

Turn on the power while holding down the clear [CLR] key and continue to hold it for at least 2 seconds to reset the unit. The unit will perform power on tests and assume the default settings. **Any stored settings will be lost.**

## Spin Knob

The spin knob is used to modify the parameter currently displayed on the DS360 display. The flashing digit indicates which digit is being incremented. The knob will modify all numeric parameters, as well as parameters which have a list of choices.

# Keypad

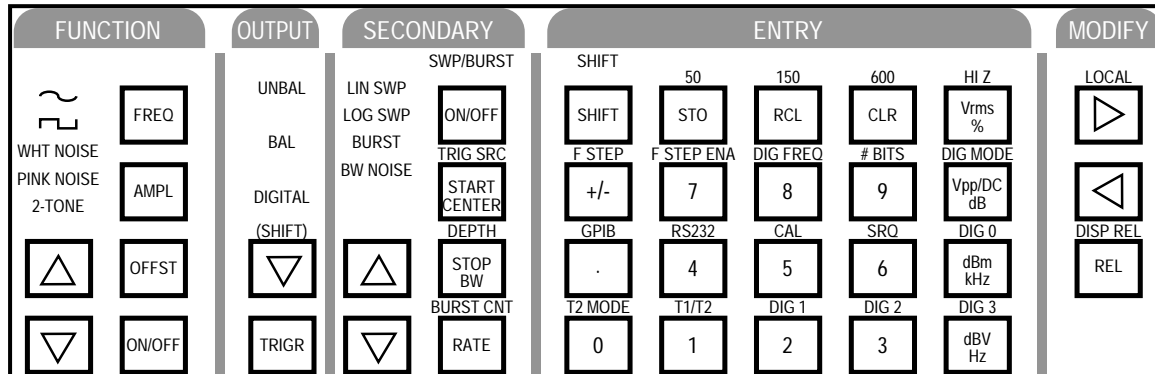

Figure 2-3 Keypad

## Function Keys

These keys control the main function output. The [^] up and [v] down function keys select between the main output functions. [FREQ], [AMPL] and [OFFST] select the output frequency, amplitude and DC offset voltage. [ON/OFF] turns the output on and off.

## Output Selection Key

The [v] key changes the output configuration from one of the three choices: unbalanced, balanced and digital. Pressing the [v] once moves one entry down the list; pressing the [SHIFT](^) moves one entry up the list.

## Trigger Key

The [TRIGR] key begins singly triggered modified functions, like single sweeps or bursts.

## Modify Function Keys

These keys control the function output modification commands for sweeps, bursts or bandwidth limited noise. The [^] up arrow and [v] down arrow keys select the modification type. The [SWP/BURST] key turns the modification function on and off. The other keys select different function modification parameters (start frequency, burst depth).

Only modify functions that are allowable for the current function type (sine, square, noise...) can be selected (i.e. sweep can be selected for sine or square, but not white noise). Only modify parameters (START FREQ, STOP FREQ ...) that are valid for the selected modify function can be changed. If a currently invalid modify parameter is selected, the unit will beep and display “not APPL” (not applicable). If a function type

change causes the currently displayed modify function to become invalid, the display will revert to the frequency [FREQ] display.

### Shift Key

The [SHIFT] key is used to select functions printed above the keys. Press the [SHIFT] followed by the [function] key to select the desired function. When the shift key is pressed, the shift LED will light. This indicates that the keypad is in “shifted” mode. Pressing [SHIFT] a second time will deactivate shift mode. **Note that in the manual, whenever [SHIFT] is indicated, the desired function is printed above the key, not on the key itself.**

### Numeric Keys

The numeric keypad allows for direct entry of the DS360's parameters. To change a parameter value, type the new value, followed by one of the [units] keys. A typing error may be corrected by pressing the [CLR] key, which recalls the old value. The [+/-] key may be selected at any time during numeric entry.

### Units Keys

The units are used to terminate numeric entries. Press the key with the desired units to enter the typed value. Some parameters have no particular units and **any** of the units keys may be used. When the amplitude is displayed, pressing one of the units keys will cause the display to change the units to the type pressed. This means that the amplitude display can be changed from V<sub>pp</sub>, V<sub>rms</sub>, dBm and dBV without entering a new value.

### Cursor Keys

The [>] cursor right and [<] cursor left keys move the flashing digit to the right and left of the display. They also switch between parameters which have a list of choices.

### Rel Key

The [REL] key changes the amplitude display to the relative display mode. The amplitude is displayed in dB relative to the value when [REL] was pressed. Pressing [REL] a second time changes the amplitude display back to normal. Pressing [SHIFT][REL] shows the V<sub>pp</sub> amplitude that the display is rel'd to.

# Outputs

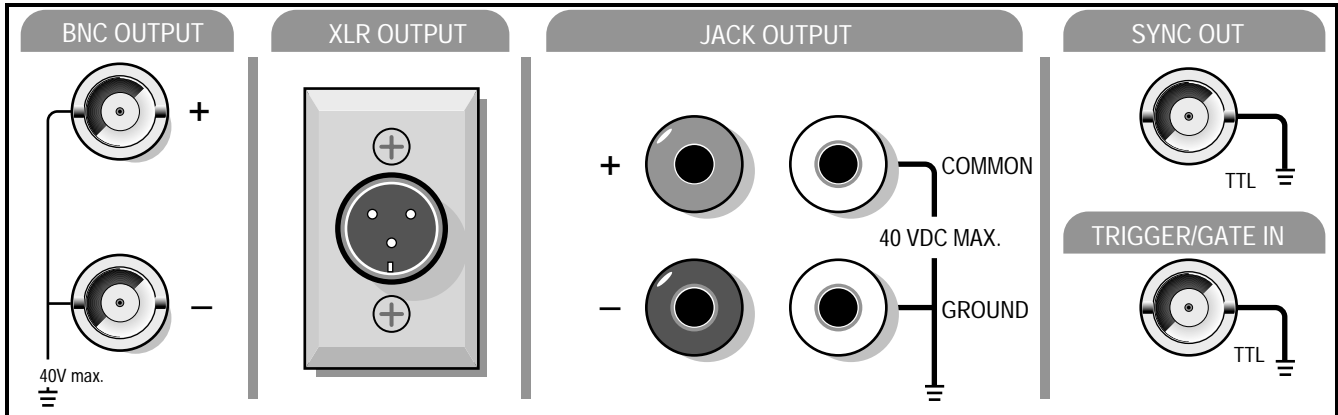

Figure 2-4 Outputs

## Function Output

The three output types are connected in parallel. There are three separate sets of output connectors: BNC, XLR and banana plugs. The different output signals are the positive output, negative output, common and chassis ground. The connectors are configured as listed below.

Function Output Connections

Output Signal	BNC Connection	XLR Connection	Banana Plug
Positive Output	+ BNC Center contact	Pin 2	+ (red) jack
Negative Output	- BNC Center contact	Pin 3	- (white) jack
Common	Both BNC Shields	Pin 1	Common (black) jack
Ground		Pin 4	Ground (green) jack

The positive and negative outputs are both referenced to the common, which may be floated  $\pm 40 V_{DC}$  from the chassis ground. The output impedance of the outputs is selectable. If the output is terminated into an incorrect impedance the output amplitude will be incorrect and may exhibit increased distortion.

## Sync Output BNC

This output is a squarewave synchronized to the main function output. Its shield is connected to chassis ground and **cannot** be floated.

## Trigger / Gate In BNC

A low to high TTL signal on this input begins externally triggered bursts and sweeps. For gated output, a TTL high gates the output on and a TTL low gates the output off. The BNC shield is connected to chassis ground and **cannot** be floated.

# Indicators

STATUS		OUTPUT	IMPEDANCE	TRIGGER	FREQ	AMPL	OFFSET
REM	SRQ	ON	50	INT	STR/C	STP/BW	REL
ACT	ERR	OFF	150	EXT	TONE1	TONE 2	DEPTH
		TRIG'D	600	SINGLE	COUNT	TRIGR	RATE
			HI Z	GATE			

Figure 2-5 Indicator LED's

## Status LEDs

These 4 LEDs indicate the DS360's status.

### Status LEDs

Name	Function
REM	The DS360 is in GPIB remote status. The [>] cursor right key returns local control.
SRQ	The DS360 has requested service on the GPIB.
ACT	Flashes for RS232 or GPIB activity.
ERR	Flashes on error in a command.

## Configuration LEDs

These LEDs indicate the output configuration, source impedance and triggering mode of the DS360.

### Configuration LEDs

Heading	Display LED	Parameter
OUTPUT	ON	Output On
	OFF	Output Off
	TRIG'D	Sweep or Burst Triggered
IMPEDANCE	50	50 Ω Output Impedance
	150	150 Ω Output Impedance
	600	600 Ω Output Impedance
	Hi-Z	Hi-Z Output Impedance
TRIGGER	INT	Internal Trigger for Sweeps or bursts
	EXT	External Trigger for Sweeps or Bursts
	SINGLE	Single Trigger for Sweeps or Bursts
	GATE	External Gate for Bursts only

**Parameter LEDs**

These LEDs indicate which parameter is currently displayed in the parameter display.

**Parameter LEDs**

<b>Display LED</b>	<b>Parameter</b>
FREQ	Output Frequency
AMPL	Output Amplitude
OFFSET	Output Offset
STARTF	Start Frequency for Sweeps Center Frequency for Bandwidth Limited Noise
STOPF	Stop Frequency for Sweeps Cutoff Frequency for Bandwidth Limited Noise
REL	Indicates that the amplitude display is in REL mode. Does not indicate a specific display.
TONE1	Indicates that Amplitude and Frequency Displays refer to TONE 1. Does not indicate a specific display.
TONE2	Indicates that Amplitude and Frequency Displays refer to TONE 2. Does not indicate a specific display.
DEPTH	Off Level Depth for Bursts
COUNT	Burst Count for Bursts
TRIGR	Trigger Source for Sweeps and Bursts
RATE	Burst Rate for Bursts

# Display



Figure 2-6 Display

## Parameter Display

This 8 digit display shows the value of the currently displayed parameter. Error, status messages and configuration information may also appear on the display.

## Units LEDs

These LEDs indicate the units of the displayed value. If no LED is lit the number displayed has no units or is seconds (for noise bursts).

Units LEDs

Display LED	Meaning
Hz	Hertz
dB	dB relative to preset value
V <sub>P-P</sub>	Volts Peak-to-Peak
KHz	Kilohertz
dBV	dB relative to 1 V <sub>RMS</sub> into selected source impedance
V <sub>DC</sub>	Volts DC
%	% (used with BURST DEPTH)
dBm	dB relative to 1mW into selected source impedance
Vrms	V <sub>RMS</sub>

## Rear Panel Features

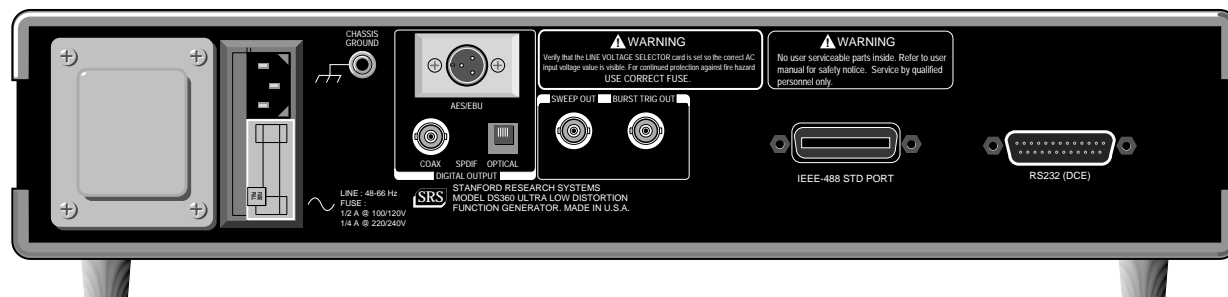

Figure 2-7 Rear Panel

### Power Entry Module

The power entry module is used to fuse the AC line, select the line voltage and block high frequency noise from entering or exiting the instrument. The DS360 uses a detachable three wire power cord for connection to the power source and the protective ground. All exposed metal parts of the unit are tied to the outlet ground to protect against electrical shock. Always use an outlet which has a properly connected protective ground.

### Caution

This instrument may be damaged if operated with the LINE VOLTAGE SELECTOR set to the wrong AC line voltage, or if the wrong fuse is installed.

Do not attempt to service or adjust this instrument while it is plugged into a live outlet.

### Line Voltage Selection

The DS360 operates from a 100, 120, 220 or 240  $V_{RMS}$  nominal AC power source having a line frequency of 50 or 60 Hz. Before connecting the power cord to a power source, verify that the LINE VOLTAGE SELECTOR card, located in the rear panel fuse holder, is set so the correct AC input voltage is visible.

Conversion to other AC sources requires a change in the fuseholder voltage card position and fuse value. Disconnect the power cord, open the fuse holder and rotate the fuse lever to remove the fuse. Remove the small printed circuit board and select the operating voltage by orienting it so the correct voltage is visible when pushed back into its slot. Rotate the fuse-pull lever back to its normal position and insert the correct fuse into the holder.

### Line Fuse

Verify that the correct fuse is installed before connecting the line cord. For 100/120  $V_{RMS}$  use two 1/2 amp fuses. For 220/240  $V_{RMS}$  use two 1/4 amp fuses.



## Outputs and Computer Interface



Figure 2-8 Outputs & Computer Interfaces

### IEEE-488 Connector

The 24 pin IEEE-488 connector allows a host computer to control the DS360 via the IEEE-488 (GPIB) instrument bus. The GPIB address of the unit is accessed by pressing [SHIFT][GPIB]. The [>] cursor right key is the instrument “local” key.

### Serial RS232 Connector

The RS232 interface connector is configured as a DCE (transmit on pin 3, receive on pin 2). The Baud Rate is accessed by pressing [SHIFT][RS232]. The interface parameters are: word length 8 bits, no parity and 2 stop bits.

### Sweep Out

This output generates a short TTL pulse at the beginning of each sweep. It can be used to synchronize an external device to a sweep. Its shield is connected to chassis ground and **cannot** be floated.

### Burst Out

This TTL output goes high for the “ON” portion of a burst and low for the “OFF” portion. It can be used to synchronize an external device to a burst. Its shield is connected to chassis ground and **cannot** be floated.



## Chapter 3

# Operation

The following sections describe the operation of the DS360. The first section describes the basics of setting a function, including setting the function type, amplitude, frequency and offset. The second section explains setting the output configuration, including the output type and source impedance. The third section explains sweeps, bursts and bandwidth limited noise. The final section explains storing and recalling setups, running self tests and setting up the computer interfaces.

### In this Chapter

---

<b>Power On</b>	<b>3-3</b>
Caution	3-3
Reset	3-3
<b>Setting Functions</b>	<b>3-4</b>
Function Type	3-4
Frequency	3-4
Amplitude	3-5
Unbalanced Amplitude Ranges	3-6
Balanced Amplitude Ranges	3-7
Offset	3-8
Function On/Off	3-8
<b>Output Configuration</b>	<b>3-9</b>
Output Type	3-9
Source Impedance	3-10
<b>Modify Function</b>	<b>3-11</b>
Modify Function Type	3-11
Modify Function On/Off	3-11
Modify Function Parameters	3-11
Sweeps	3-11
Bursts	3-13
Bandwidth Limited Noise	3-16
<b>Instrument Setup</b>	<b>3-18</b>
Default Settings	3-18
Storing and Recalling Settings	3-18
GPIB Setup	3-19
SRQ	3-19
RS-232 Setup	3-19
Self Tests	3-20

## 3-2 Operation

---

<b>Troubleshooting</b>	<b>3-21</b>
GPIB Problems	3-21
RS232 Problems	3-21
Error Messages	3-22
Operational Messages	3-23

# Power On

## Power On

When power is first applied to the DS360 the unit will display its serial number and ROM version. Next the DS360 will initiate a series of self-tests of the internal circuitry and stored data. The test should take about 3 seconds and end with the message "TEST PASS". If the self-test fails the DS360 will display an error message indicating the nature of the fault (see the **TROUBLESHOOTING** section at the end of this chapter for more details). The unit will attempt to operate normally after a self test failure; press any key to clear the error message.

### Caution

This instrument may be damaged if operated with the LINE VOLTAGE SELECTOR set for the wrong AC line voltage or if the wrong fuse is installed.

## Reset

Turn the power on while holding down the [CLR] key and continue to hold it down for at least 1 second to reset the unit. The unit will perform its self-tests and assume its default settings.

### Attention

The DS360 has two distinct modes: analog and digital. These are selected as described in the output configuration section. When the unit is in one mode (digital or analog), parameters of the other mode **cannot** be selected or queried from either the front panel or the computer interface. This chapter describes the operation of the analog mode; for information on the digital mode, see **Chapter 5**.

## Setting Functions

The following section describes how to set the parameters for the basic functions of the DS360, including function type, frequency, amplitude, offset and function on/off.

### Function Type

The DS360 output function type is selected using the [^] up and [v] down function arrow keys. Press the appropriate key until the desired function LED is lit. The peak-to-peak amplitude will remain the same between different functions. If the amplitude is displayed in any other units, they will be adjusted to reflect a constant peak-to-peak voltage. If the modify function is enabled and the type is incompatible with the new function, the modify function will be changed to a legal value (the parameters will remain unchanged).

The available functions are sinewaves, squarewaves, white noise, pink noise and two-tones. Sinewaves and squarewaves are self explanatory. White Noise is a Gaussian weighted distribution, filtered to 200 kHz and is flat in amplitude over that region. Pink Noise extends from 10 Hz to 200 kHz with a -3 dB/octave amplitude response. There are two types of 2-Tones; sine-sine 2-tones and sine-square 2-tones. To display the current mode, press [SHIFT][T2 MODE]. To change modes, press the [>] right or [<] cursor key, or turn the spin knob. When in 2-Tone, only one set of parameters (amplitude, frequency) are available at a time. To toggle between displaying Tone 1 and Tone 2 parameters, press [SHIFT][T1/T2].

### Frequency

To display the current output frequency, press the [FREQ] key. The frequency is displayed in Hz or kHz, depending on which unit LED is lit. The DS360 has 6 digits of frequency resolution or 10 mHz, whichever is greater. Any non displayed digits are zeroed to avoid having slightly different output frequencies for a given display value.

The frequency ranges and resolution are shown in the table below.

**Frequency Range of Functions**

Function	Frequency Range	Frequency Resolution
Sinewaves	0.01 Hz - 200.000 kHz	0.01 Hz or 6 digits
Squarewaves	0.01 Hz - 200.000 kHz	0.01 Hz or 6 digits
White Noise	200 kHz White Noise (fixed)	
Pink Noise	200 kHz Pink Noise (fixed)	
Sine-Sine Two-Tone Tone1 & Tone2	0.01 Hz - 200.000 kHz	0.01 Hz or 6 digits
Sine-Square Two-Tone Tone1 (Sine) Tone2 (Square)	0.01 Hz - 200.000 kHz 0.1 Hz - 5.0 kHz	0.01 Hz or 6 digits 2 digits

If the function is set to White Noise or Pink Noise the character of the noise is fixed, unless a modification function is active. The frequency is not adjustable and displays "noise".

The frequency of both Tone1 and Tone 2 may be set. For Sine-Sine 2-Tones, both frequencies are set the same as for normal sines, as is Tone1 for Sine-Square 2-Tones. The squarewave in sine-square two-tones has limited frequency range and resolution. It can be set from 0.1 Hz to 5.0 kHz with 2 digits of resolution (i.e. 4.9 kHz or 110 Hz, not 104 Hz).

To set the frequency of a function, type the new value on the keypad and complete the entry with the appropriate units (Hz, kHz). Or change the frequency by using the spin knob. If too high a value is entered, the DS360 will beep and display "Range Err.". If a value less than 0.01 Hz is entered, the frequency is set to 0.001 Hz.

For output frequency settings only, the spin knob increment can be set to a value other than the normal single digit increment (set by the [>] right and [<] left cursor keys). To display the step size mode, press [SHIFT][FSTEP ENA]. To toggle between the normal and the special step size mode, turn the spin knob or press either of the cursor keys. To display the current special step size, press the [SHIFT] [F STEP] keys. To set the special step size, type a new value and complete the entry with the appropriate units (Hz, kHz). The spin knob cannot be used to enter the step size.

## Amplitude

To display the current amplitude, press the [AMPL] key. The amplitude may be set and displayed in Vpp, Vrms, dBm, dBV and dB from a relative value. The current units are indicated by the LEDs at the right of the display. dBm is defined as dB relative to 1 mW of power into the selected source impedance. dBV is defined as dB relative to 1 Vrms into the selected source impedance. (See the section on setting impedance and output configuration for more detail). The amplitude resolution is 4 digits or 1  $\mu$ V, whichever is greater for Vpp and Vrms. For dBm, dB and dBV it is 3 digits or 0.1 dB, whichever is greater.

The units of the amplitude display may be changed between Vpp, Vrms, dBm and dBV without changing the amplitude by pressing the corresponding units key. When the DS360 is switched from one function to another, the peak-to-peak amplitude remains the same, but the values for other units will change to reflect the new function. To change the amplitude, type a new value on the keypad, followed by the appropriate units (Vrms, Vpp, dBm, dBV) key. Or use the spin knob to modify the current value. If the DS360's attenuator setting changes, the output will briefly go to zero as the amplitude is changed.

### 2-Tone Amplitude

The amplitudes of Tone1 and Tone2 are maintained separately from the other function amplitudes (i.e. when changing from another function to 2-Tone, the amplitudes will be the last 2-Tone amplitudes set, not the value of the previous function). In addition to the amplitude limits shown below, the amplitudes of Tone1 and Tone2 cannot differ by more than 1:1000 or:

$$0.001 \leq \frac{AmpTone1}{AmpTone2} \leq 1000$$

If the amplitude of either Tone1 or Tone 2 is set outside of these limits, the unit will beep, display the message 'Adj 2tA' (adjusting 2Tone Amplitude) and modify the other Tone amplitude so it is within the allowable range.

**Relative Amplitude**

Amplitude may be set in dB relative to a user defined value for all functions except 2-Tone. To make the currently displayed value the relative value, press [REL]. To set the value in dB (relative to the previously entered rel'd value), type the new value, followed by the [dB] key. The "rel'd" value can be displayed in Vrms, dBm or dBV, without changing the amplitude, by pressing the appropriate key. To display the "rel'd" value in Vpp, press [SHIFT][REL] which will display the Vpp value briefly. Pressing the [REL] key a second time takes the amplitude out of relative mode, as does entering a value in Vrms, dBm or dBV.

**Unbalanced Output Amplitude**

The amplitude range is limited by the DC offset, since

$$(V_{AC\ PEAK}) + |V_{DC}| \leq 20\ V \quad |V_{DC}| \leq (200 * V_{AC\ PEAK})$$

For a DC offset of zero, the amplitude range for each function is shown in the tables below for different source impedance's.

**Unbalanced Hi-Z Output Amplitude Ranges**

Function	Vpp	Vrms	dBm	dBV
Sine	10 μV - 40.00 V	4 μV - 14.14 V		-108 - 23.0
Square	10 μV - 40.00 V	5 μV - 20.00 V		-106 - 26.0
White Noise #	10 μV - 40.00 V	1μV - 5.714 V		-119 - 13.1
Pink Noise #	10 μV - 40.00 V	2μV - 5.000 V		-120 - 11.5
2-Tone *	10 μV - 40.00 V	3 μV - 14.14 V		-108 - 23.0

**Unbalanced 50 Ω Output Amplitude Ranges**

Function	Vpp	Vrms	dBm	dBV
Sine	5 μV - 14.40 V	2 μV - 5.091 V	-102 - 27.1	-115 - 14.1
Square	5 μV - 14.40 V	3 μV - 7.200 V	-102 - 27.1	-112 - 17.1
White Noise #	5 μV - 14.40 V	1 μV - 2.057 V	-102 - 27.1	-125 - 4.2
Pink Noise #	5 μV - 14.40 V	1 μV - 1.800 V	-102 - 27.1	-126 - 2.7
2-Tone *	5 μV - 14.40 V	2 μV - 5.091 V	-102 - 27.1	-115 - 14.1



**Unbalanced 600 Ω Output Amplitude Ranges**

Function	Vpp	Vrms	dBm	dBV
Sine	5 μV - 20.00 V	2 μV - 7.071 V	-112 - 19.2	-115 - 17.0
Square	5 μV - 20.00 V	3 μV - 10.00 V	-112 - 19.2	-112 - 20.0
White Noise #	5 μV - 20.00 V	1 μV - 2.857 V	-112 - 19.2	-125 - 7.0
Pink Noise #	5 μV - 20.00 V	1 μV - 2.500 V	-112 - 19.2	-126 - 5.5
2-Tone *	5 μV - 20.00 V	2 μV - 7.071 V	-112 - 19.2	-115 - 17.0

**Balanced Output Amplitude**

Since there is no offset allowed for balanced output, the amplitude is only limited:

$$V_{AC\ PEAK} \leq 40\ V$$

The amplitude range for each function is shown in the tables below for different source impedance's.

**Balanced Hi-Z Output Amplitude Ranges**

Function	Vpp	Vrms	dBm	dBV
Sine	20 μV - 80.00 V	8 μV - 28.28 V		-103 - 29.0
Square	20 μV - 80.00 V	10 μV - 40.00 V		-100 - 32.0
White Noise #	20 μV - 80.00 V	3 μV - 11.43 V		-113 - 19.1
Pink Noise #	20 μV - 80.00 V	3 μV - 10.00 V		-114 - 17.6
2-Tone *	20 μV - 80.00 V	8 μV - 28.28 V		-103 - 29.0

**Balanced 50 Ω and 150 Ω Output Amplitude Ranges**

Function	Vpp	Vrms	dBm	dBV
Sine	10 μV - 28.80 V	4 μV - 10.18 V	-96 - 33.2	-109 - 20.2
Square	10 μV - 28.80 V	6 μV - 14.40 V	-96 - 33.2	-106 - 23.2
White Noise #	10 μV - 28.80 V	2 μV - 4.114 V	-96 - 33.2	-119 - 10.2
Pink Noise #	10 μV - 28.80 V	2 μV - 3.600 V	-96 - 33.2	-120 - 8.70
2-Tone *	10 μV - 28.80 V	4 μV - 10.18 V	-96 - 33.2	-109 - 20.2

**Balanced 600 Ω Output Amplitude Ranges**

Function	Vpp	Vrms	dBm	dBV
Sine	10 μV - 40.00 V	4 μV - 14.14 V	-106 - 25.2	-109 - 23.0
Square	10 μV - 40.00 V	6 μV - 20.00 V	-106 - 25.2	-106 - 26.0
White Noise #	10 μV - 40.00 V	2 μV - 5.714 V	-106 - 25.2	-119 - 13.1
Pink Noise #	10 μV - 40.00 V	2 μV - 5.000 V	-106 - 25.2	-120 - 11.5
2-Tone *	10 μV - 40.00 V	4 μV - 14.14 V	-106 - 25.2	-109 - 23.0

\* The maximum amplitude for 2-Tones is based on the **sum** of the two signals. Additionally the difference between the two signals is limited to 1000:1 (i.e. the smaller of the two can be no smaller than 1000x less than the larger).

## 3-8 Operation

---

\* The rms, dBm and dBV values for White & Pink Noise are based on the total power in the output bandwidth (200 kHz) at a given peak-to-peak setting.

### Offset

Press the [OFFST] key to display the DC offset. The DC offset range is limited by the amplitude, since

$$|V_{AC\ PEAK}| + |V_{DC}| \leq 20\ V \quad |V_{offset}| \leq (200 * V_{AC\ PEAK}).$$

The offset has three digits of resolution, however the smallest increment is determined by the sum of the peak AC amplitude and the DC offset. The tables below show the offset range and resolution for given amplitude settings. Offset is not active for balanced outputs and is the same polarity for both unbalanced outputs (a +2 V<sub>DC</sub> offset sets both the positive and negative offsets to +2 V) for unbalanced outputs.

#### Unbalanced Hi-Z

$ V_{AC\ PEAK}  +  V_{DC} $	Offset Resolution (V <sub>DC</sub> )
0 to 12.59 mV	10 μV
12.60 mV to 125.9 mV	100 μV
126.0 mV to 1.259 V	1 mV
1.260 V to 20.00 V	10 mV

#### Unbalanced 50 Ω

$ V_{AC\ PEAK}  +  V_{DC} $	Offset Resolution (V <sub>DC</sub> )
0 to 6.319 mV	10 μV
6.320 mV to 63.19 mV	100 μV
63.2 mV to 0.6319 V	1 mV
0.6320 V to 7.200 V	10 mV

#### Unbalanced 600 Ω

$ V_{AC\ PEAK}  +  V_{DC} $	Offset Resolution (V <sub>DC</sub> )
0 to 6.319 mV	10 μV
6.320 mV to 63.19 mV	100 μV
63.20 mV to 0.6319 V	1 mV
0.6320 V to 10.00 V	10 mV

To set a new offset, type the desired value on the keypad, followed by the [V<sub>DC</sub>] key. Or use the spin knob to modify the currently displayed offset value.

### Function On / Off

The output may be switched on or off by pressing the [ON/OFF] key. The output status is indicated on the main display under the OUTPUT heading. When the output is off, the output connectors are terminated into the select source impedance.

---

# Output Configuration

This section describes how to configure the output type and source impedance of the DS360.

## Output Type

The DS360 has two different output types: unbalanced and balanced. The currently selected output type is indicated by the LED in the OUTPUT section. To change to the other output selection, press [v] output down key. The significance of the different output types is listed below.

### Unbalanced Output

An unbalanced output signal refers to a signal that is referenced to a common DC potential. Peak-to-peak or RMS voltages are measured to that common level. Most normal function generators use this configuration. Both the positive and negative outputs of the DS360 have the selected source impedance and output voltage amplitude present. The two signals are equivalent, the only difference being that the positive signal is 180° out of phase with the negative signal.

When the unbalanced output is selected, the amplitude limits are set to the unbalanced output values. The offset function is available. Offsets are the **same** polarity for both outputs (a +2 V<sub>DC</sub> offset will offset both the positive and negative outputs by 2 volts).

### Balanced Output

A balanced output signal refers to a signal that is measured to another signal, **not** a common DC potential, although one may be present. Peak-to-Peak or RMS voltages are measured from signal to signal instead of signal to common. This configuration is used for many audio applications. Typically the measured voltage will be twice the voltage (or +6 dB) from each signal to a common signal. The output voltage and source impedance is measured between the positive and negative outputs on the DS360. The signals are the same as for the unbalanced case (albeit a different amplitude), however their amplitude is measured differently.

When the balanced output is selected, the amplitude limits are set to the balanced output values. The offset function is **not** active, since offset has no meaning for a balanced output.

## Source Impedance

The source impedance of the DS360 can be set to different values. When the output of the DS360 is terminated into the selected source impedance, the amplitude set on the front panel will be the amplitude seen by the load. If the output is not terminated into the selected load, the amplitude set on the front panel will be incorrect. If one of the source impedance's is selected (not Hi-Z), and the unit is terminated into a high impedance, the amplitude will be double the set value. The Hi-Z should be used when the output is terminated into a high impedance. The Hi-Z amplitude will be correct (<1% error) for all load impedance's larger than 5 kΩ.

### 3-10 Operation

---

The output impedance changes for unbalanced and balanced. Each output (positive and negative) has the selected source impedance for unbalanced outputs. For balanced outputs, each output has 1/2 the selected source impedance.

**Source Impedance for + or - Output**

Source Impedance	Unbalanced	Balanced
50Ω	50Ω	25Ω
150Ω		75Ω
600Ω	600Ω	300Ω
Hi-Z	25Ω	25Ω

The selected source impedance is displayed under the **IMPEDANCE** heading to the left of the display. To change the impedance, press **[SHIFT][impedance]**, where impedance is either 50Ω, 150Ω, 600Ω or Hi-Z. It is not necessary to press an entry key to select source impedance's.

If changing the source impedance from Hi-Z or 600Ω to 50Ω or 150Ω would cause an out of range amplitude or offset, the following will occur. The DS360 will beep, display the message **Adj volt** and adjust the amplitude to 14.4V<sub>PP</sub> and the offset to 0 V<sub>DC</sub>.

# Modify Function

This section describes how to set the modify functions on the DS360, including sweeps, bursts and bandwidth limited noise.

## Modify Function Type

Modify functions are associated with the different output functions. Only the options available for the currently selected function type are accessible in the MODIFY FUNC list. Sweeps are available for sine and square waves; bursts are available for sines, squares, white and pink noise; bandwidth limited noise is available for white noise only. No modify functions are active for 2-Tones. Press the [^] up or [v] down keys in the MODIFY FUNC area until the desired selection is lit. If you cannot select the desired type of modify function, verify that the selected function type allows that modify function type.

## Modify Function On/Off

To activate or deactivate the currently selected modification, press the [ON/OFF] key in the MODIFY FUNC area. The SWP/BURST LED is lit to indicate that the modification function is active.

## Modify Function Parameters

The parameters for modify functions can be entered whether the function is currently active or not. Only modify parameters (START FREQ, STOP FREQ ...) that are valid for the selected modify function can be changed. If a currently invalid modify parameter is selected, the unit will beep and display “not APPL” (not applicable). If a function type change causes the currently displayed modify function to become invalid, the display will revert to the frequency display.

## Sweeps

Frequency sweeps are active for sine and square waves. Sweeps are increasing in frequency and can be linear or logarithmic in nature. Frequency changes during the sweep are phase continuous, including the wrap around from stop to start frequency. The rate can be set from 0.1 Hz to 3.1 kHz, with 2 digits of resolution. Sweeps can be continuous, externally triggered or singly triggered. The DS360 has a Sweep output on the rear panel that can be used to synchronize an oscilloscope or other external device to the DS360 sweep output. Use the MODIFY FUNC [ON/OFF] key to begin or end sweeping.

### Note

Sweeps have an amplitude rise at the wrap around point (stop frequency to start frequency transition) due to ringing in the reconstruction filter. The effect is minimal for stop frequencies below about 130 kHz. If high stop frequencies and large output amplitudes (>30 Vpp, unbalanced) are used, it is possible to cause the output to clip. To

minimize this, keep stop frequencies below 130 kHz when sweeping at maximum amplitude.

### Sweep Type

Press the [^] up or [v] down key in the MODIFY FUNC area until the LIN SWP or LOG SWP LED is lit. The output frequency of a linear sweep changes linearly during the sweep time. The output frequency of a log sweep changes exponentially during the sweep time, spending equal time in each decade of frequency (for example, in a log sweep from 1 kHz to 100 kHz, the sweep will spend half of the time in the 1 kHz to 10 kHz range and the other half in the 10 kHz to 100 kHz range).

### Sweep Trigger Source

Sweeps can be continuously triggered, externally triggered or singly triggered. Internally triggered sweeps use an internal sweep rate generator (see the SWEEP RATE described below) to set the sweep repetition rate. Externally triggered sweeps begin on the rising edge of a TTL signal supplied by the user to the TRIGGER/GATE IN BNC on the front panel. Singly triggered sweeps begin by pressing the front panel [TRIGR] key or from one of the computer interfaces.

The current trigger source is indicated by an LED under the TRIGGER heading next to the frequency display. To view the current trigger source for modification, press the [SHIFT][TRIG SRC] keys. To change the trigger source, use the spin knob or [>] right or [<] left cursor keys.

While the DS360 is sweeping, the TRIGD (triggered) LED is lit. It should be lit continuously for internally triggered sweeps. For external or single triggered sweeps, it will be lit for the duration of the sweep only. If a new trigger is received during an external or single triggered sweep including the specified dead time (see SWEEP RATE for details on dead time), the ERR LED will flash and any triggers will be ignored.

### Sweep Rate

The sweep rate can be set continuously from 0.1 Hz (10 s) to 3.1 kHz (0.32 ms) with 2 digits of resolution (for example, you can set 1.1 kHz, but not 101 Hz). The period of a sweep is simply 1/Sweep Rate.

To display the current sweep rate, press the [RATE] key. To change the sweep rate, type a new value on the numeric keypad, followed by the appropriate units (Hz or kHz). Or use the spin knob to modify the current value. If a non-valid rate is entered, (1.001 kHz for example) the DS360 will round the value down to the nearest legal value. If an out of range value is entered, the DS360 will beep, display "Rate Err" and flash the ERR LED.

### Internal Trigger

There are no additional restrictions on internal sweep rates.

### External or Single Trigger

The DS360 synchronizes the external (or single) trigger signal to its internal clock. Because of this, there is an uncertainty of between 0 and 0.317 ms from the start signal

(from the TRIGGER IN, computer interface or front panel) and the actual beginning of the sweep. The SWEEP OUT BNC signal, which goes high at the beginning of the sweep, should be used if it is necessary to synchronize the DS360 with an external device, instead of the triggering signal. In addition, there is a dead time of between 0 and 0.317 ms between successive sweeps. If a trigger comes during a sweep or during the dead time following a sweep, it will be treated as an error and ignored. These factors limit the maximum rate that a sweep can be triggered externally (or singly) to somewhat less than for internally triggered sweeps. To **never** miss a trigger, the maximum external (or single) trigger rate is given by:  $1/(\text{Ext Sweep Freq}) = 1/(\text{Sweep Rate}) + 0.634 \text{ ms}$ . Sweeps can be triggered somewhat faster than this if it is permissible to skip triggers. Trigger errors simply indicate that a trigger has been ignored, but do not effect the output signal in any way.

### Start and Stop Frequencies

The DS360 can sweep over any portion of its frequency range, from 0.001 Hz to 200.000 kHz. To display the current start or stop frequency, press the [START] or [STOP] key. To change the start or stop frequency, type a new value using the numeric keypad, followed by the appropriate units (Hz or kHz). If an out of range frequency is entered, the DS360 will beep, display "FREQ Err" and flash the ERR LED.

### Bursts

Bursts are active for sinewaves, squarewaves, white noise and pink noise. A burst of sines or squares consists of a certain number of complete cycles at a particular level (the "ON" level), followed by another number of cycles at a reduced level (the "OFF" level). Time intervals (instead of number of cycles) are used for noise signals. This pattern can be triggered, either internally, externally, or on a single-shot basis. Additionally the output can be gated on and off by an external signal.

Bursts are programmed in # of counts for sine and square waves and in seconds for noise signals. The "ON" time is entered as the Burst Count. The Burst Rate is the combination of both the "ON" and "OFF" times as shown below.

$$\text{BURST RATE} = \text{BURST COUNT} + \text{OFF CYCLES}$$

The burst "OFF" level is set in percent or dB relative to the "ON" level and can range from 0 to 100% in 0.1% increments or from 0dB to -60dB in 0.1dB increments. The DS360 has a BURST output on the rear panel that can be used to synchronize an oscilloscope or other external device to the DS360 burst output. This signal remains a TTL high for the duration of the "ON" time and a TTL low for the "OFF" time. Use the MODIFY FUNC [ON/OFF] key to begin or end bursting.

### Burst Trigger Source

Bursts can be continuously triggered, externally triggered or singly triggered. Internally triggered bursts use an internal burst rate generator (see the BURST RATE described below) to set the repetition rate. Externally triggered bursts begin on the rising edge of a TTL signal supplied by the user to the TRIGGER/GATE IN BNC on the front panel. Singly triggered bursts begin by pressing the front panel [TRIGR] key or from one of the

computer interfaces. In addition, the output can be gated on and off from the TRIGGER/GATE IN BNC, with TTL high setting the “ON” level and TTL low setting the “OFF” level.

The current trigger source is indicated by an LED under the TRIGGER heading next to the display. To view the current trigger source for modification, press the [SHIFT][TRIG SRC] keys. To change the trigger source, use the spin knob or [>] right or [<] left cursor keys.

During the “ON” time for bursts the TRIGD (triggered) LED is lit. If a new trigger is received during an external or single triggered burst the ERR LED will flash. Any triggers received during an external or single triggered burst will be ignored. Trigger errors only indicate that a trigger occurred during a burst; there is no effect on the output waveform.

### Sine and Square Wave Bursts

#### Internal Burst Rate

The burst rate is the total number of cycles in a burst, both the “ON” and “OFF” cycles, when generating internally triggered bursts. It is set in integer number of cycles and can range from 2 to 65535 (1 for the 1/2 cycle output. See below). In addition, it must be at least one count greater than the Burst Count. To display the current burst rate, press the [RATE] key. To modify the rate, type the new value in number of counts and press any of the entry keys. Or use the spin knob to modify the displayed value. If an illegal value is entered, the unit will beep, display “Range Er” and flash the ERR LED. If a value that is less than the current burst count is entered, the unit will beep, flash the ERR LED, display “AdjBur” (adjust burst), and adjust the Burst Count to one less than the Burst Rate.

#### External Burst Rate

External or single triggered sine or square bursts are synchronized to the output zero crossings. Because of this, there is an uncertainty of 0 to one cycle from the start signal (from the TRIGGER IN, computer interface or front panel) and the actual beginning of the burst. The BURST OUT BNC signal, which goes high at the beginning of the burst should be used if it is necessary to synchronize the DS360 with an external device, instead of the triggering signal. This limits the maximum rate that a burst can be triggered externally (or singly) to somewhat less than for internally triggered bursts. To **never** miss a trigger, the maximum external (or single) trigger rate is given by:

$$ExtTrigFreq < \frac{OutputFreq}{BurstCount + 1}$$

Bursts can be triggered somewhat faster than this if it is permissible to skip triggers.

#### Burst Count

The burst count is the number of “ON” cycles (or high level) in a burst. It is set in integer number of cycles and can range from 1 to 65534. In addition it must be at least one count less than the Count Rate. To display the current Burst Count, press the [SHIFT][BURST CNT]. To modify the count, type the new value in number of counts and press any of the entry keys. Or use the spin knob to modify the displayed value. If an illegal value is entered, the unit will beep, display “Range Er” and flash the ERR LED.



If a value that is greater than or equal to the current burst rate is entered the unit will beep, display **BurRatEr** (burst rate error) and flash the ERR LED.

## Noise Bursts

### Internal Burst Rate

The burst rate for noise is set in seconds. Any entry key may be used and no units are displayed. The rate can vary between 20  $\mu$ s to 600.0 s, with 4 digits of resolution. In addition, the rate must be greater than and within 4 digits of the Burst Count. To display the current burst rate, press [RATE]. To modify the rate, type the new value (in seconds) and press any entry key. Or use the spin knob to modify the displayed value. If an illegal value is entered, the unit will beep, display **Range ER** and flash the ERR LED. If a value less than the current burst count is entered, the unit will beep, flash the ERR LED, display **AdjBur** and adjust the Burst Count to 1/10 of the current Burst Rate. If the Burst Rate is adjusted to a value more than 4 digits above the current Burst Count, the Burst Rate is adjusted to the lowest allowable value (i.e. if the initial Burst Count is 0.001s, setting the Burst Rate to 600s will adjust the Burst Count to 0.1s).

### External Bursts Rate

External noise bursts are not synchronized to anything, so there isn't the uncertainty from the TRIGGER IN signal and the start of bursts that there is for sine or square waves. To **never** miss a trigger, the maximum external (or single) trigger rate is given by:

$$ExtTrigFreq < \frac{1}{BurstCount}$$

when the burst count is expressed in seconds.

### Burst Count

The burst count for noise is the "ON" time in a noise burst. Any entry key can be used and no units are displayed. The burst count can vary between 10  $\mu$ s to 599.9 s, with 4 digits of resolution. In addition, the burst count must be less than and within 4 orders of magnitude of the Burst Rate. To display the current burst count, press [SHIFT][BURST CNT]. To modify the count, type the new value (in seconds) and press any entry key. Or use the spin knob to modify the displayed value. If an illegal value or a value greater than or equal to the current burst rate is entered, the unit will beep, display **Range Er** and flash the ERR LED.

### Burst Depth

The burst depth is the attenuation of the "OFF" level compared to the "ON" level. To enter a specific "OFF" level it is necessary to enter an "ON" level and calculate the required attenuation to generate the desired "OFF" level. The burst depth on the DS360 can vary from 0 to 100%, with a 0.1% resolution. It can also be displayed or entered in dB. 0% depth (no output) can only be set in percent. If 0% is set and the units are changed to dB, the display will show "999" as an overflow value since it cannot be displayed in dB.

To view the current depth, press [SHIFT][DEPTH]. To change the depth, type the new value followed by the appropriate units key (% or dB). Or use the spin knob to modify

the current value. If an out of range value is entered, the unit will beep, display **Depth Err** and flash the ERR LED.

### **Gated Output**

When the DS360 is set to gated output mode (see Burst Trigger Source) the output is gated on and off from the TRIGGER/GATE IN BNC. A TTL high level outputs the “ON” level and TTL low the “OFF” level. For sine and square waves, level changing occurs at zero crossings. Because of this there is an uncertainty of between 0 and one cycle from the rising edge of the TRIGGER/GATE IN BNC and the actual level change of the output. Similarly there is an uncertainty at the falling edge. The BURST OUT BNC signal, which is high while the “ON” level is active should be used if it is necessary to synchronize the DS360 with an external device instead of the external gating signal. This is not a problem for gated noise signals, since it isn’t synchronized to anything.

### **1/2 Cycle Burst**

The DS360 has a special mode where it can output a 1/2 cycle burst of a sine or square waves. The polarity is fixed (positive for the positive output; negative for the negative output). To use the 1/2 cycle burst count, type .5, followed by an entry key. The spin knob cannot be used to enter this value. The burst rate can be set to any legal value and all triggering modes are valid.

## **Bandwidth Limited Noise**

Bandwidth limited noise is active for white noise only. The purpose of bandwidth limited noise is to maximize the noise power in the frequency of interest. The bandwidth limited white noise in the DS360 maintains a constant RMS voltage over nearly all bandwidths and center frequencies (see information in the CENTER FREQUENCY section below for more information). The bandwidth limiting is accomplished using a 3-Pole Butterworth Filter, for both the high and low pass filters. Use the MODIFY FUNC [ON/OFF] key to begin or end bandwidth limited noise.

### **Bandwidth**

The Bandwidth of the bandwidth limited noise can be set to any of the following values: 100 Hz, 200 Hz, 400 Hz, 800 Hz, 1.60 kHz, 3.20 kHz, 6.40 kHz, 12.8 kHz, 25.6 kHz, 51.2 kHz or 102.4 kHz. These correspond to 1/2 bandwidth frequency spans, starting from the full bandwidth of the white noise.

To display the current bandwidth, press the [BW] key. To enter a new value, type the value followed by the appropriate units key (Hz or kHz). Or use spin knob to modify the current value. If the bandwidth is not entered exactly, the DS360 will round down to the next legal value for all values above 100 Hz; below 100 Hz will round to 100 Hz. If an out of range value is entered, the DS360 will beep, display **Freq Err** and flash the ERR LED.

### Center Frequency

The center frequency can vary from 0 Hz to 200.000 kHz in 200 Hz increments. To display the current center frequency, press the [CENTER] key. To change the center frequency, type a new value using the numeric keypad, followed by the appropriate units (Hz or kHz). If an out of range frequency is entered, the DS360 will beep, display "Freq Err" and flash the ERR LED.

For bandwidth limited noise with high center frequencies and/or wide bandwidths there can potentially be a reduction in noise power. When

$$\text{CENTER FREQUENCY} + 1/2 \text{ BANDWIDTH} > 200 \text{ kHz}$$

the amplitude will be slightly reduced. This is due to the fact that the white noise generator has a bandwidth of 200 kHz, so any part of the noise bandwidth above 200 kHz will be filtered.

## Instrument Setup

This section describes the DS360's default settings, storing and recalling settings, setting the computer interfaces and running the self-tests.

### Default Settings

Press [RCL][0] to recall the DS360's default settings. This is a good place to begin whenever you wish to start the instrument from a known state. The default settings are listed below. See **Chapter 5** for information on the default settings for the digital output.

**Default Settings**

Setting	Default Value
Function	Sine
Frequency	1.00000 kHz
Amplitude	1.000 Vrms
Offset	0.00 V <sub>DC</sub>
Output On/Off	On
Output Type	Unbalanced
Output Mode	Analog
Output Impedance	Hi-Z
Modify Function	Linear Sweep
Modify Function On/Off	Off
Start Frequency	1.000 Hz
Stop Frequency	100.000 kHz
Sweep Rate	1.0 kHz
Trigger Source	Internal
Burst Depth	50%
Burst Count	1
Burst Rate	10
2-Tone Tone 1 Frequency	1.00000 kHz
2-Tone Tone 2 Frequency	10.0000 kHz
2-Tone Tone 1 Amplitude	1 Vrms
2-Tone Tone2 Amplitude	1 Vrms
2-Tone Mode	Sine-Sine
Bandwidth Limited Noise Center Frequency	0 Hz
Bandwidth Limited Noise Bandwidth	3.2 kHz
GPIB Address	As set
RS-232 Baud Rate	As set

### Storing and Recalling Settings

#### Storing Settings

The DS360 can store up to 9 independent instrument setups in non-volatile RAM, separate from the default settings ([RCL][0]). To store the current instrument setup, press [STO] followed by a location number (1-9). After any of the units keys are pressed, the

message **Store Done** will be displayed to indicate that the settings have been stored. Memory location 0 is the location of the defaults and cannot be stored to. Storing to it will generate a range error.

### Recalling Settings

To recall a stored setting, press [RCL] followed by a location number (0-9). After pressing any of the units keys to enter the location, the message **Rcl Done** will be displayed to indicate that the settings have been recalled. If nothing had been stored in the selected location or if the stored settings had been corrupted, the message **Rcl Err** will be displayed. Note that [RCL][0] recalls the default settings.

### GPIB Setup

Press [SHIFT][GPIB] to display the current GPIB address. Use the spin knob to modify the address or enter the number directly from the keypad and one of the entry keys. The GPIB address can be set from 0 to 30.

Pressing [SHIFT][GPIB] a second time will display the last 256 characters of data that has been received by the DS360. This display is a scrollable 3 character window into the DS360's input data queue. The data is displayed in ASCII hex format, where each character is represented by 2 hexadecimal digits. The most recently received character is indicated by the decimal point to the right of the digit. Turning the spin knob to the left moves the window earlier into the data queue; turning it to the right moves later into the queue. The display window cannot be moved later than the last character received.

### SRQ

The user may issue an user SRQ (service request) over the GPIB. Only one SRQ (user or otherwise) can be active at a time; the host computer must acknowledge any pending SRQ's before a new one is sent. Note that the user SRQ is in addition to the usual service requests based on the unit's status.

To issue an user SRQ, press [SHIFT][SRQ], followed by any of the entry keys. The message **Send SRQ** will appear prior to pressing the entry key. After the entry key is pressed (assuming that no other SRQ is pending), the message **Sent SRQ** will appear, and the SRQ LED will appear. The SRQ LED will go off after the host computer does a serial poll of the DS360.

See **Chapter 4** on programming for additional information on the GPIB.

### RS-232 Setup

Press [SHIFT][RS232] to display the RS-232 baud rate setting. Use the spin knob to modify the baud rate. The baud rate **cannot** be entered directly from the keypad. Baud rates supported are 300, 600, 1200, 2400, 4800, 9600 and 19.2 k.

Pressing [SHIFT][RS232] a second time will display the last 256 characters of data that has been received by the DS360. This display is a scrollable 3 character window into the

DS360's input data queue. The data is displayed in ASCII hex format, where each character is represented by 2 hexadecimal digits. The most recently received character is indicated by the decimal point to the right of the digit. Turning the spin knob to the left moves the window earlier into the data queue; turning it to the right moves later into the queue. The display window cannot be moved later than the last character received.

See **Chapter 4** on programming for additional information on the RS-232.

### Self-Tests

The self tests check out much of the internal circuitry, including the CPU, data memory, ROM program memory, calibration constants integrity, stored settings integrity, DSP and DSP memory. The self tests are executed on power-up and take about 3 seconds to run. If all the self tests pass, the unit will display "tEst PASS" and operate normally. If they fail, the unit will stop and display an error message. Pressing any key will cause the unit to attempt to operate normally. Typically the user should power cycle the instrument to attempt to clear the error. Some errors are transient in nature and will disappear. If the problems continue, contact Stanford Research Systems for service information.

See the TROUBLESHOOTING section later in this chapter for a list and explanation of error messages.

# Troubleshooting

## Nothing Happens on Power On

Make sure that the power entry module on the rear panel is set for the correct line voltage, that the correct fuse is installed and that the line cord is inserted **all** the way into the power entry module. The selected line voltage should be visible through the clear window in the power entry module, just below the fuse, when the power cord is removed.

## Reset

If the unit becomes “hung” or inoperative, or displays no sensible message, a full reset may fix the problem. To perform a full reset, hold down the [CLR] key while turning the power on. This procedure initializes the RAM and recalls all factory calibration values. It also destroys any stored settings. If you only want to return the instrument to its default state, press [RCL][0], which doesn’t clear all stored data.

## Unable to Set Parameters

Be certain that the unit is set for the correct mode (analog or digital) for the parameters being adjusted (i.e. number of bits cannot be set in analog mode). This is true for both front panel and computer operation. The output mode is indicated by the LED’s in the OUTPUT section.

## GPIB Problems

Make certain that the GPIB address of the DS360 matches what the controller expects. The address can set to any address from 0 to 30, however the default address is 8. If possible it is a good idea to use this address, unless you are otherwise constrained. To display the address, press [GPIB], and use the keypad or spin knob to modify it.

The DS360 will ignore its front panel keypad when Remote Enable (REN) is asserted by the GPIB. This “REMOTE” state is indicated by the REM LED. To return to LOCAL operation (ie to return control to the front panel) press the [LOCAL] key. Controlling programs may inhibit the ability to return to LOCAL operation by asserting the Local-Lockout state (LLO). The only way to return from this state is to release it over the GPIB or by performing a total reset.

A linefeed character is sent with an End Or Identify (EOI), to terminate strings from the DS360. Be certain that your controller has been configured to accept this sequence.

## RS-232 Problems

Make certain that the baud rate of the controller and the DS360 agree. The baud rate can be set from 300 to 19.2 k; the default is 9600. If it is practical, it is a good idea to use this value. To display the baud rate press [RS232], and use the keypad or knob to modify the

## 3-22 Operation

---

value. The DS360 is configured to send or receive: 2 stop bits, 8 data bits and no parity bits. When data is being received by the DS360, the ACT LED will flash. If this LED is not flashing there is no data being received by the DS360.

When connecting the DS360 to a PC use a standard PC serial cable, not a “null modem” cable. The DS360 is a DCE (Data Communications Equipment) device, and should be connected with a straight cable to a DTE device (Data Terminal Equipment). The “minimum” cable needs pins 2, 3 and 7. For hardware handshaking, pins 5 and 20 (CTS and DTR) should also be passed. Occasionally pins 6 and 8 (DSR and CD) will be needed; these lines are always asserted by the DS360.

### Error Messages

The DS360 has two types of error messages, operational error messages and self test error messages. Operational errors include entering out of range values or incorrect units. Self test error messages only occur when the unit is running its internal self tests.

#### Operational Errors

Message	Meaning
AC-DC ER	The Vac+ Vdc  value exceeded the limit for the current setting.
AC ERR	The amplitude entered is out of the allowable range.
BUR.RAT.ER	Burst Rate Error. Burst Count > Rate Count.
NO.Cal.JPR	No Cal jumper. Calbyte cannot be written without setting the calibration jumper.
NOT APPL	The parameter is not applicable to the current instrument setting.
OFF ERR	The offset entered is out of the allowable range.
OUTQ ERR	Output queue error. The output queue is full.
RANGE ER	The value entered is out of the allowed range for the current parameter.
RCL ERR	Memory error found on power up or when recalling a stored setting. (Also occurs when recalling a setting that hasn't been previously stored)
SYN ERR	The command syntax is invalid.
TOUT ERR	Time out error when writing DSP memory.
UNITS ER	The units set with AMPL, T1AA, T2BA or DPTH commands are not allowable or nonexistent.



**Self-Test Errors**

Message	Meaning
CPU ERR	The DS360 detected a problem with the CPU.
CODE ERR XX	The DS360 detected a ROM checksum error. XX is the expected checksum value.
SYSD ERR	The DS360 failed its RAM read / write test.
CALD ERR	The calibration data in RAM is corrupted. The factory calibration data will be reloaded from PROM.
DSP 0	DSP not responding. The instrument must be power cycled.
DSP 1 followed by: xxxxxx	DSP data bus error. The message is followed by a six digit (hex) code, corresponding to each data line (of 24) that is in error.
DSP 2 followed by: xxxxxx	DSP address bus and memory cell error. The message is followed by a six digit (hex) code, made up of three words. Bits 0-15 are DSP address lines 0-15. Bits 16-18 are set if there is an error on the X, Y or P memory spaces. Bits 19-21 are set if there is an error in the low (D0-7), middle (D8-15) or high (D16-23) bytes of the memory space.
TST n	This message displays an encoded version of the bits 0-3 of the test register (see the *TST command).

**Other Messages**

The DS360 displays a number of messages to inform the user of its operational status or of actions the unit has taken. All possible messages are listed below.

**Operational Messages**

Message	Meaning
ADDR xx	GPIB address. The value xx is the current GPIB address.
ADJ BUR	The Burst count has been adjusted to be lower than the current Rate count.
ADJ DFR	The digital output frequency has been adjusted to an allowable range after changing the sampling frequency.
ADJ VOLT	The amplitude and offset has been adjusted to an allowable value after changing the source impedance.
ADJ 2TA	The non-selected 2Tone amplitude has been adjusted to within a 1:1000 range of the currently selected tone.
ADJ 2TAl	Tone 1 and Tone 2 amplitudes and offset have been adjusted to an allowable value after changing the source impedance.
ADJ 2TFR	Tone 2 Frequency has been adjusted after the Tone 2 mode was changed to squarewave.
BAUD xxxx	RS232 baud rate. The value xxxx is the current baud rate.
CLEAR	Second selection of the CAL menu. If the calibration jumper is set correctly, pressing any unit key will recall the default calbytes from PROM.

### 3-24 Operation

---

LD DONE	This message occurs after successfully loading the DSP memory.
RECALL	Recall menu. It should be followed by a number between 0-9.
RCL DONE	This message will be displayed for about 1 second after a successful recall.
STORE	Store menu. Should be followed by a number between 1-9. (Store 0 will generate a Range Error).
STO DONE	This message will be displayed for about 1 second after a successful store.
SEND SRQ	SRQ menu. Pressing any units key will generate a GPIB SRQ, assuming no other SRQ is pending.
SRQ SENT	This message is displayed for about 1 second after a SRQ is successfully sent.
SRC.INT SRC.ETN SRC.SNGL SRC.GATE	The Trigger Source for sweeps (int, ext, single) or bursts (int, ext, single, gate).
STEP OFF (/ON)	Frequency Step Enable. (Valid for FREQ and 2Tone FREQ).

## Chapter 4

# Remote Programming

### In this Chapter

---

<b>Index of Commands</b>	<b>4-2</b>
<b>Introduction</b>	<b>4-5</b>
Communication with GPIB	4-5
Communication with RS-232	4-5
Status Indicators and Queues	4-5
Command Format	4-6
Interface Ready and Status	4-6
GET (Group Execute Trigger)	4-7
<b>Command Syntax</b>	<b>4-8</b>
<b>Function Output Control Commands</b>	<b>4-9</b>
Function	4-9
Frequency	4-9
Amplitude	4-9
Offset	4-9
Output Commands	4-9
Relative Mode	4-10
Frequency Step	4-10
2-Tone Commands	4-10
<b>Modify Function Commands</b>	<b>4-12</b>
Trigger	4-12
Modify Function	4-12
Trigger Source	4-12
Sweep Commands	4-12
Burst Commands	4-13
Bandwidth Limited Noise Commands	4-14
<b>Setup Control Commands</b>	<b>4-15</b>
System Commands	4-15
Front Panel Commands	4-15

## 4-2 Remote Programming

---

<b>Status Reporting Commands</b>	<b>4-16</b>
<b>Hardware Test &amp; Calibration Commands</b>	<b>4-17</b>
<b>Status Byte Definition</b>	<b>4-19</b>
<b>Example Programs</b>	<b>4-21</b>
GPIB Communications in C	4-22
RS-232 Communications in BASIC	4-23

# Index of Commands

---

## Variables

i, j, k, n	integers
x	real numbers

---

## Function Output Control Commands

FUNC (?) i	4-9	0=sin, 1=sqr, 2=wht noise, 3=pink noise, 4=2Tone.
FREQ (?) x	4-9	Sets Output Freq to x.
AMPL (?) x	4-9	Sets Ampl to x; must include VP, VR, dB, dV or dm.
OFFS (?) x	4-9	Sets Output Offset to x.
OUTE (?) i	4-9	Output Enable (i=1), Disable (i=0).
OUTM (?) i	4-9	Output Mode 0=unbal, 1=bal.
TERM (?) i	4-10	Source Impedance 0=50Ω, 1=150Ω, 2=600Ω, 3=HiZ.
RELA (?) i	4-10	Sets Relative Amplitude Mode ON (i=1) or OFF (i=0).
STPE (?) i	4-10	Freq Step Enable (i=1) Disable (i=0).
FSTP (?) x	4-10	Sets Freq Step to x.
TTAA (?) x	4-10	Sets Tone A amp to x; must include VP, VR, dB, dV or dm.
TTBA (?) x	4-11	Sets Tone B amp to x; must include VP, VR, dB, dV or dm.
TTAF (?) x	4-11	Sets Tone A frequency to x.
TTBF (?) x	4-11	Sets Tone B frequency to x.
TTMD (?) i	4-11	Sets 2-Tone Mode to sine (i=0) or square (i=1).

---

## Modify Function Commands

*TRG	4-14	Triggers a single sweep or burst.
MENA (?) i	4-14	Modify Function Enable (i=1) or Disable (i=0).
MTYP (?) i	4-14	Sets the modify function type to Lin Swp, Log Swp, Burst, BWNoise for i=0,1,2,3.
TSRC (?) i	4-14	Sets the trigger source to Int, Ext, Single or Gate for i=0,1,2,3.
STFR (?) x	4-14	Sets Sweep Start Frequency to x.
SPFR (?) x	4-14	Sets Sweep Stop Frequency to x.
RATE (?) x	4-14	Sets Sweep Rate to x.
BCNT (?) x	4-15	Sets Burst Count to x (i=.5, 1-65534).
RCNT (?) i	4-15	Sets Burst Rate to x (i=1-65535).
DPTH (?) x	4-15	Sets Burst Depth to x; must include DB or PR (%).
NBCT (?) x	4-15	Sets Noise Burst Count to x.
NRCT (?) x	4-15	Sets Noise Rate Count to x.
BNDW (?) x	4-16	Sets Noise BW to 100, 200, 400, 1.6k, 3.2k, 6.4k, 12.8k, 25.6k, 51.2k, 102.4k.
CENF (?) i	4-16	Sets BW Noise Center Frequency to x.

---

## 4-4 Remote Programming

---

### Setup Control Commands

*IDN?	4-17	Returns the DS360 device identification string.
*RCL i	4-17	Recalls stored setting number i (0 to 9).
*SAV i	4-17	Saves the current instrument setting as setting number i (1 to 9).
KEYS (?) i	4-17	Simulates the pressing of a front panel key.

### Status Reporting Commands

*CLS	4-18	Clears all status registers.
*ESE (?) i	4-18	Sets/Reads the Standard Event Status Byte Enable register.
*ESR? {i}	4-18	Reads the value of the Standard Event Status register {or bit i only}.
*PSC (?) i	4-18	Sets the value of the power on status clear bit.
*SRE (?) i	4-18	Sets/Reads the Serial Poll Enable register.
*STB? {i}	4-18	Reads the value of the Serial Poll Byte {or bit i only}.
DENA (?) i	4-18	Sets/Reads the value of the DDS enable register.
STAT? {i}	4-18	Reads the value of the DDS register {or bit i only}.

### Hardware Test and Calibration Commands

*TST?	4-19	Starts self test and returns status when done.
\$FCL	4-19	Recalls the factory calibration bytes.
\$FIL (?) n	4-19	Sets the State variable Filter to the n-th filter.
\$NOF (?) n	4-19	Sets the filter mode to n (0,1 or 2).
\$PRE (?) n	4-19	Sets the DS360 pre-amplifier attenuators to range n (0 to 31).
\$PST (?) n	4-20	Sets the DS360 post-amplifier attenuators to range n (0 to 3).
\$WRD (?) j,k	4-20	Sets the value of calibration word j to k.

## Introduction

The DS360 Ultra Low Distortion Function Generator may be remotely programmed via either the RS232 or GPIB (IEEE-488) interfaces. Any computer supporting these interfaces may be used to program the DS360. Both interfaces are receiving at all times; the DS360 will respond to the interface that sent the query.

### Communicating with GPIB

The DS360 supports the IEEE-488.1 (1978) interface standard. It also supports the required common commands of the IEEE-488.2 (1987) standard. Before attempting to communicate with the DS360 over the GPIB interface, the DS360's device address must be set. To display the present address, press [SHIFT][GPIB]. The new address can be modified by using the keypad, followed by an entry key, or by using the spin knob.

### Communicating with RS232

The DS360 is configured as a DCE (transmit on pin 3, receive on pin 2) device and supports CTS/DTR hardware handshaking. The CTS signal (pin 5) is an output indicating that the DS360 is ready, while the DTR signal (pin 20) is an input that is used to control the DS360's data transmission. If desired, the handshaking pins can be ignored and a simple 3 wire interface (pins 2, 3 and 7) may be used. The RS232 baud rate is displayed by pressing [SHIFT][RS232]. A new baud rate can be entered using the spin knob only; the baud rate **cannot** be entered using the numeric keys. The word length, parity and number of stop bits are fixed and cannot be modified. They are configured as follows: 2 stop bits, 8 data bits and no parity.

### Status Indicators and Queues

To assist in programming, the DS360 has 4 interface status indicators which are located at the left side of the display. The REM LED is on when the DS360 is in a remote state (front panel locked out). The ACT LED is on whenever data is being received by the DS360. The ERR LED flashes when an error, such as an illegal command or out of range parameter, has been detected. The SRQ LED is on when the DS360 generates a service request. SRQ remains on until a GPIB serial poll is completed.

To help find programming errors, the DS360 can display the interface buffers on the display. The GPIB queue is accessed by pressing [SHIFT][GPIB] twice in succession. The RS232 queue is accessed by pressing [SHIFT][RS232] twice in succession. The last 256 characters received by each interface can be displayed in a scrollable 3 character window. The data is displayed in ASCII hex format, where each character is represented by 2 hexadecimal digits. The most recently received character is indicated by a decimal point to the right of the digit. Turning the knob counterclockwise moves the data window earlier into the data queue; turning the knob clockwise moves the data window later into the queue. The window cannot be moved later than the last character received.

### Command Format

Communication with the DS360 uses ASCII characters. Commands may be in either UPPER or lower case. A command to the DS360 consists of a four character command mnemonic with an optional ?, arguments if necessary and a command terminator. The terminator must be a linefeed <lf> or carriage return <cr> on RS232, or a linefeed <lf> or EOI on GPIB. No command processing occurs until a terminator is received. Commands function identically on RS232 and GPIB whenever possible. Command mnemonics beginning with an asterisk (\*) are IEEE-488.2 (1987) defined common commands. These also function identically on RS232. Commands may require one or more parameters. Multiple parameters are separated by a comma (.). Multiple commands may be sent on the same line by separating them with semicolons (;).

There is no need to wait between commands. The DS360 has a 256 character buffer and processes commands in the order received. If the buffer fills, the DS360 will hold off handshaking on the GPIB and attempt to hold off handshaking on RS232. Similarly the DS360 has a 256 character output buffer to store output until the host computer is ready to receive it. If either buffer overflows, both buffers are cleared and an error is reported.

The present value of a particular parameter may be determined by querying the DS360 for its value. A query is formed by spending a question mark (?) with the command mnemonic and omitting the desired parameter from the command. Values returned from the DS360 are sent as a string of ASCII characters terminated with a carriage return <cr> on RS232 and by a linefeed <lf> on GPIB. If multiple query commands are sent on one command line (separated by semicolons), the answers will be sent individually, each with a terminator.

Examples of Commands:

FREQ 1000 <lf>	Set the Output Frequency to 1.0 kHz
*TRG <lf>	Trigger a sweep or burst
FUNC? <lf>	Query the output function.

### Interface Ready and Status

The No Command bit in the Serial Poll Status Byte signals that the DS360 is ready to receive and execute commands. When a command is received, this bit is cleared, indicating that command execution is in process. No other commands will be processed until this command is complete. Commands received during this time are stored in the buffer to be processed later. Only GPIB serial polling will generate a response while a command is in progress. When all pending commands have executed, the No Command bit is set again. By checking the No Command bit, a host computer can ensure that all previously sent commands have finished before sending a new command.

Since most commands execute very quickly, the host computer does not need to continually check the No Command bit. Commands can be sent one after another and they will process immediately. However some commands, such as self tests, may require a long time to execute. In addition, the host computer may need to check that these commands executed without error. In these cases, the status should be queried.



When using the GPIB interface, serial polling may be used to check the No Command bit while operation is in progress. After the bit becomes set, the ERR bit may be checked to verify successful completion of the command.

If the RS232 interface is used, or serial polling is not available, then the \*STB ? and \*ESR ? status query commands may be used to query the Status Bytes. Since the DS360 processes one command at a time, the status query will not be processed until the previous command is complete. Thus a response to the status query itself signals that the previous operation is finished. The query response may then be checked for various errors.

## **SRQ**

The user may issue an user SRQ (service request) over the GPIB. Only one SRQ (user or otherwise) can be active at a time; the host computer must acknowledge any pending SRQ's before a new one is sent. Note that the user SRQ is in addition to the usual service requests based on the unit's status. See the section on status bytes later in this chapter for more information.

## **GET (Group Execute Trigger)**

The GPIB command GET will have the same effect as a \*TRG command. If the DS360 is configured for a single triggered sweep or burst, then the GET bus command will trigger a sweep or burst. If the DS360 is not configured for one these, the command will be ignored.

## Command Syntax

The four letter mnemonic in each command sequence specifies the command. The rest of the sequence consists of parameters. Parameters shown in { } are not always required. Generally, parameters in { } are required to set a value in the DS360. Multiple parameters are separated by commas. Multiple commands may be sent on one command line by separating them with semicolons (;).

The present value of a parameter may be determined by sending a query command. Commands that may be queried have a question mark in parentheses (?) after the mnemonic. Commands that may ONLY be queried have a ? after the mnemonic. Commands that MAY NOT be queried have no ?. A query is formed by including the question mark ? after the command mnemonic and omitting the queried parameter from the command. The query parameters shown in { } are NOT sent with a query. The query returns the value of these parameters. Values are returned as a string of ASCII characters.

**NOTE:** Do NOT send ( ) or { } as part of the command.

Variables are defined as follows:

i, j, k, n	integers
x	real numbers

All numeric variables may be expressed in integer, floating point or exponential formats (i.e. the number five can be either 5, 5.0 or 05E1). Strings are sent as a sequence of ASCII characters.

## Function Output Control Commands

Note: The analog output control commands may be selected only when the analog output type is selected. If these commands are sent when the unit is in digital mode a “Not Appl” (not applicable) message will be displayed on the screen and syntax error will occur. The command OUTD0 (analog output) should be sent at the beginning of any program that uses the analog output. Also be aware that a couple of commands share common mnemonics and values with the digital output (FUNC, STPE, FSTP).

---

### **FUNC (?) i**

The FUNC command sets the output function type to i as shown below. The FUNC? query returns the current function.

<u>i</u>	<u>Function</u>
0	Sine
1	Square
2	White Noise
3	Pink Noise
4	2 Tone

---

### **FREQ (?) x**

The FREQ command sets the frequency to x Hertz. The FREQ? query returns the current output frequency. The frequency is set and returned with 10mHz resolution. If the current waveform is NOISE, an error will be generated and the frequency will not be affected. This command doesn't set the frequencies for 2-Tones. See TTAf and TTBF commands for 2-Tone frequencies.

---

### **AMPL (?) x**

The AMPL command sets the output amplitude to x. The value x must consist of the numerical value and a units indicator. The units may be VP ( $V_{pp}$ ), VR ( $V_{RMS}$ ), DB (dB in relative mode only, see RELa command below), DM (dBm) or DV (dBV). For example, the command AMPL1.0DM will set the output to 1.0 dBm. Setting the amplitude to 0 Volts will produce DC only, (no AC component), with the output controlled by the OFFS command. For amplitude- offset limits, see chapter 3.

The AMPL?x query, where x is the units indicator, will return the amplitude in those units. For example, the AMPL?VR query will return 10.00VR. The returned units will match the units indicator and the amplitude will be returned in those units.

This command doesn't set the amplitude for 2-Tones. See TTAA and TTBA commands for 2-Tone amplitudes.

---

### **OFFS (?) x**

The OFFS command sets the output DC offset to x volts. The OFFS? query returns the current value of the DC offset. For amplitude-offset limits see chapter 3.

## 4-10 Remote Programming

---

### OUTE (?) i

The OUTE command disables the output for i=0 and enables the output for i=1. The OUTE? query returns the current status of the output.

---

### OUTM (?) i

The OUTM command selects the output mode of the instrument. For i=0 the output is unbalanced and for i=1 it is balanced. The OUTM? query returns the current output mode.

---

### TERM (?) i

The TERM command sets the output source impedance as indicated in the table below. The TERM? query returns the current source impedance setting. An error will be generated if the output impedance selected is not valid for the current output mode.

<b>i</b>	<b><u>Source Impedance</u></b>
0	50 $\Omega$
1	150 $\Omega$
2	600 $\Omega$
3	Hi-Z

---

### RELA (?) i

The RELA command sets (queries) the relative mode for the output amplitude. For i=1, the relative mode is active, with the current amplitude setting as the relative amplitude. New values are set using dB relative to this value. For i=0 (or when setting a value in units other than dB) the relative mode is inactive. This command has no effect when 2Tone is selected.

---

### STPE (?) i

The STPE command enables (i=1) or disables (i=0) the usage of the frequency step, which is set by the FSTP command. The STPE? query returns the current step enable mode.

---

### FSTP (?) x

The FSTP command sets the frequency step to x Hertz. The FSTP? query returns the current step frequency. The step is active only for the main frequency (FREQ) and STPE (step enable) = 1. The value x may range between 10mHz and 200kHz.

When the frequency step is enabled, it becomes the knob increment value.

---

### TTAA (?) x

The TTAA command sets the Tone 1 amplitude to x. The value x must consist of the numerical value and a units indicator. The units may be VP ( $V_{pp}$ ), VR ( $V_{RMS}$ ), DM (dBm) or DV (dBV). For example, the command TTAA1.0VP will set the Tone 1 to 1.0Vpp. The maximum value for the sum of Tone 1 and Tone 2 amplitude, as well as the ratio of the two, is limited as described in chapter 3. If the DS360 must modify the amplitude of either Tone 1 or 2, due to under or over ranging, a message is sent on the front panel and bit 3 in the DDS register is set.

---

The TTAA? query will return the amplitude in the currently displayed units. For example, if the display shows 10.0 V<sub>RMS</sub>, the TTAA? query will return 10VR. If the units indicator is sent along with the command (such as TTAA?VP), the returned units will match the units indicator and the amplitude will be returned in those units.

---

**TTBA (?) x**

The TTBA command sets the Tone 2 amplitude to x. The value x must consist of the numerical value and a units indicator. The units may be VP (V<sub>pp</sub>), VR (V<sub>RMS</sub>) DM (dBm) or DV (dBV). For example, the command TTBA1.0VP will set the Tone 2 to 1.0Vpp. The maximum value for the sum of Tone 1 and Tone 2 amplitude, as well as the ratio of the two, is limited as described in chapter 3. If the DS360 must modify the amplitude of either Tone 1 or 2, due to under or over ranging, a message is sent on the front panel and bit 3 in the DDS register is set.

The TTBA? query will return the amplitude in the currently displayed units. For example, if the display shows 10.0 V<sub>RMS</sub>, the TTBA? query will return 10VR. If the units indicator is sent along with the command (such as TTBA?VP), the returned units will match the units indicator and the amplitude will be returned in those units.

---

**TTAF (?) x**

The TTAF command sets the Tone1 frequency to x Hertz. The TTAF? query returns the current Tone1 frequency. The frequency is set and returned with 10mHz resolution.

---

**TTBF(?) x**

The TTBF command sets the Tone 2 frequency to x Hertz. The TTBF? query returns the current Tone 2 frequency. The Tone 2 frequency must be a legal value for the 2-Tone type selected (see TTMD). If Tone 2 is a sinewave, the frequency is set and returned with 10mHz resolution. If Tone 2 is a squarewave, the frequency is set and returned with 2 digits of resolution (ie. 4.8kHz or 110Hz, but not 101Hz).

---

**TTMD (?) i**

The TTMD command sets the Tone 2 mode to either sine (i=0) or square (i=1). The TTMD? query returns the current Tone 2 mode.

---

# Modify Function Commands

Note: Most of the modify function parameters may be selected at any time that the unit is in analog mode. To observe the changes effecting the output, be sure that the appropriate modifying type is selected and the modify function is on. Some of the parameters **cannot** be modified for all settings. These are indicated below. When this occurs, a "Not Appl" (not applicable) message will be displayed on the screen and syntax error will occur.

If these commands are sent when the unit is in digital mode a "Not Appl" (not applicable) message will be displayed on the screen and syntax error will occur. The command OUTD0 (analog output) should be sent at the beginning of any program that uses the analog output.

---

### \*TRG

The \*TRG command triggers a burst or a single sweep. The trigger source must be set to SINGLE.

---

### MENA (?) i

The MENA command enables the modify function for i=1 and disables it if i=0. The MENA? query returns the current modify function status.

---

### MTYP (?) i

The MTYP command sets the modify function type to i as described in the table below. The MTYP? query returns the current type.

<u>i</u>	<u>Modify Function</u>
0	LIN SWEEP
1	LOG SWEEP
2	BURST
3	BW NOISE

If the modify function is changed to a type which is incompatible with the currently selected output waveform, a range error will be sent and the command will be ignored.

If the parameter currently being displayed is undefined for the new MTYP (for example: start freq and burst), the "Not Appl" message will appear, a range error will be returned and the display will be changed to FREQ, regardless of what was displayed previously.

---

### TSRC (?) i

The TSRC command sets the trigger source for bursts and sweeps to i as described in the table below. The TSRC? query returns the current trigger source.

<b>i</b>	<b>Source</b>
0	INTERNAL
1	EXTERNAL
2	SINGLE
3	GATE (burst only)

If the trigger source is set to gate when the unit is in burst mode and the unit is changed to sweep mode, the trigger source will change to internal.

---

**STFR (?) x**

The STFR (?) command sets (queries) the sweep start frequency to x Hertz. An error will be generated if the start frequency is higher than the current stop frequency.

---

**SPFR (?) x**

The SPFR (?) command sets (queries) the sweep stop frequency to x Hertz. An error will be generated if the stop frequency is lower than the current start frequency.

---

**RATE (?) x**

The RATE command sets the sweep rate to x Hz. The value x is rounded to 2 significant digits and may range from 0.1 Hz to 3.1 kHz. The RATE? query returns the sweep rate in Hertz.

---

**BCNT (?) x**

The BCNT command sets the burst count to x (1 to 65534). The BCNT? query returns the current burst count. The maximum value of x is limited to 1 less than the value of RCNT (see below). If this is exceeded a range error will occur. The burst count can also be set to .5, for a 1/2 cycle burst. The string “.5” must be sent **without** a leading zero (do not send “0.5”!).

---

**RCNT (?) i**

The RCNT command sets the burst rate count to i (1 to 65535). The RCNT? query returns the current burst rate count. Setting RCNT less than or equal to the current BCNT will adjust BCNT to RCNT-1 (to .5 if RCNT is 1). An ‘ADJ BUR’ message will be displayed and bit 3 (parameter adjust) will be set in the DDS status byte.

---

**DPTH (?) x**

The DPTH command sets the burst depth to x. The value x must consist of the numerical value and a units indicator. The units must be DB (dB) or PR (%). If a 0% value is set, a query of DB will return -999 as an overflow value. The range for x is 0% to 100% or 0dB to -60dB. A query must be followed by one of the units indicators, for example DPTH?DB.

---

**NBCT (?) x**

The NBCT command sets the Noise Burst Count to x. The NBCT? query the Noise Burst Count. The minimum value of x must be within 4 digits of NRCT; the maximum must be less than NRCT (i.e. for NRCT=3s, NBCT ranges from 1ms to 2.999s).

## 4-14 Remote Programming

---

---

### NRCT (?) x

The NRCT command sets the Noise Rate Count to x. The NRCT? query returns the current value of this parameter. x may range from 2  $\mu$ s to 600 s.

If NRCT is set to a value lower than NBCT, NBCT is adjusted to NRCT/10; if NRCT is set to a value more than 4 digits above NBCT, NBCT is adjusted to the lowest allowable in that range (i.e. if NBCT=1ms, setting NRCT to 600s will adjust NBCT to 100ms). An 'ADJ BUR' message is displayed and bit 3 in the DDS Status Byte is set in this case.

---

### BNDW (?) i

The BNDW command sets the white noise bandwidth to one of the following frequencies: 100 Hz, 200 Hz, 400 Hz, 800 Hz, 1.6 kHz, 3.2 kHz, 6.4 kHz, 12.8 kHz, 25.6 kHz, 51.2 kHz, 102.4 kHz. The value i is always expressed in Hz. Values lower than 100 Hz will set BNDW to 100 Hz; all other values will be rounded down.

---

### CENF (?) i

The CENF command sets the white noise center frequency to i, which ranges from 0 to 200kHz. The resolution of i is 200 Hz; all settings will be adjusted to i modulo 200. CENF? query returns the currently set value.



## Setup Control commands

### \*IDN?

The \*IDN? common query returns the DS360 device identification string. This string is in the format: “StanfordResearchSystems,DS360,sn,vn” where sn is the five digit serial number of the particular unit and vn is a 3 digit firmware version number.

### \*RCL i

The \*RCL command recalls stored setting number i, where i may range from 0 to 9. If the stored setting is corrupt or has never had anything stored in it, an execution error will be generated. RCL0 recalls the default setting of the instrument (see **Chapter 3** for the default settings).

### \*RST

The \*RST common command resets the DS360 to its default configuration, initializes the unit and runs the self tests. It behaves the same as cycling the power off and on. The communication setup is not changed. All other modes and settings are set to the default conditions and values. This command takes some time to complete.

### \*SAV i

The \*SAV command saves the current instrument settings as setting number i, where i ranges from 1 to 9 (setting number 0 is the default setting). An error will be generated if data is saved to setting 0.

### KEYS (?) i

The KEYS command simulates the pressing of a front panel key. The KEYS? query returns the keycode of the most recently pressed key. Keycodes are assigned as follows:

<u>Key Name</u>	<u>Key Code</u>	<u>Key Name</u>	<u>Key Code</u>
FUNCTION UP	1	0	21
FUNCTION DOWN	2	1	22
OUTPUT UP	3	2	23
TRIGGER	4	3	24
MODIFY FUNC UP	5	4	25
FREQ	6	5	26
AMPL	7	6	27
OFFS	8	7	28
FUNCTION ON/OFF	9	8	29
MODIFY FNC DOWN	10	9	30
SWP BURST ON/OFF	11	Vrms / %	31
START/CENTER	12	Vpp / Vdc / dB	32
STOP/BW	13	kHz / dBm	33
RATE	14	Hz / dBV	34
SHIFT	15	not used	35
STO	16	right arrow	36
RCL	17	left arrow	37
CLR	18	REL	38
+/-	19	not used	39
(.)	20	not used	40

## Status Reporting Commands

Note: See tables at the end of the programming section for Status Byte definitions.

---

**\*CLS**

The \*CLS common command clears all status registers. This command does not affect the status registers.

---

**\*ESE (?) i**

The \*ESE command sets the standard event status byte enable register to decimal value i.

---

**\*ESR? {i}**

The \*ESR common command reads the value of the Standard Event Status Register. If the parameter i is present, the value of bit i is returned (0 or 1). Reading this register will clear it, while reading bit i will clear just bit i.

---

**\*PSC (?) i**

The \*PSC common command sets the value of the power-on status clear bit. If i=1, the power-on status clear bit is set and all status registers and enabled registers are cleared at power on. If i=0, the bit is cleared and the registers maintain their values at power on.

---

**\*SRE (?) i**

The \*SRE common command sets the serial poll enable register to the decimal value of parameter i.

---

**\*STB? {i}**

The \*STB common query reads the value of the serial poll byte. If i is present, the value of bit i is returned (0 or 1). Reading this register has no effect on its value as it is a summary of other status registers.

---

**DENA (?) i**

The DENA command sets the status enable register to the decimal value of parameter i.

---

**STAT? {i}**

The STAT? query reads the value of the DDS status byte. If i is present, the value of bit i is returned (0 or 1). Reading this register will clear it while reading bit i will clear just bit i.

---

## Hardware Test and Calibration Commands

---

### \*TST?

The \*TST? common query runs the DS360 internal self tests. After the tests are complete, the test status is returned as a one byte decimal value. If the value is 0, no errors have been detected, otherwise the returned value is the encoded value of the status of the test register described below.

<u>bit</u>	<u>Meaning</u>
0	CPU error detected
1	ROM checksum error
2	RAM error detected
3	CALD calibration data chksum err
4	DSP error detected
5	unused
6	unused
7	reserved

---

**Note: The following commands are primarily intended for factory calibration of the DS360 and should never be needed during normal operation. Incorrect use of some of these commands can alter the calibration of the DS360. If this happens, perform a full reset, as described in chapter 3.**

### \$FCL

The \$FCL command recalls the factory calibration bytes. This command will generate an error if the calibration jumper is not in the correct position.

---

### \$FIL (?) i

The \$FIL command sets the State Variable Filter to the i-th filter, when a previous \$NOF1 or \$NOF2 command has been sent. In the \$NOF0 mode this command is disabled and the filter number is selected as a function of frequency. The \$FIL? query returns the currently selected filter number. The range for i is 0 to 36, where 0 means no filter is selected.

---

### \$NOF (?) i

The \$NOF command sets the filter mode to 0, 1 or 2. Mode 0 is normal, the Z80 sets the appropriate filter function of frequency and tells the DSP which filter is set. In mode 1, the Z80 sets the filter function of \$FIL command and tells the DSP that filter 0 is set. In mode 2, the Z80 sets the filter function of \$FIL command and tells the DSP which filter is set. The \$NOF query returns the current mode.

---

### \$PRE (?) i

The \$PRE command sets the DS360 pre-amplifier attenuators to range i. The integer i is the attenuation range which takes values from 0 to 31. Each range sets the pre-attenuators to  $-1.25*i$  dB. Setting the amplitude will return the attenuators to their normal position. The \$PRE? query returns the current attenuator position.

## 4-18 Remote Programming

---

---

### **\$PST (?) i**

The \$PST command sets the DS360 post-amplifier attenuators to range i. The integer i is the attenuation range, which takes values from 0 to 3. Each range sets the post-attenuators to  $-20*i$  dB. Setting the amplitude will return the attenuators to their normal position. The \$PST? query returns the current attenuator position.

---

### **\$WRD (?) j, {k}**

The \$WRDj,k command sets the value of calibration word j to k. Parameter j may have a value from 0 to 950, while k may range from - 3270 to 65535. This command will generate an error if the calibration jumper is not enabled. NOTE: This command will alter the calibration of the DS360. To recall the factory calibration, use the \$FCL command (Factory Calibration Calbytes). Calibration bytes cannot be altered unless the warm-up bit has been set. NOTE: This is a factory command only and is not available for customer use.

## Status Byte Definitions

The DS360 reports on its status by means of three status bytes: the Serial Poll Byte, the Standard Status Byte and the DDS Status Byte.

Upon power on, the DS360 may either clear all of its status enable registers or maintain them in the state they were in on power down . The \*PSC command determines which action will be taken.

The status bits are set to 1 when the event or state described in the tables below has occurred or is present.

---

### Serial Poll Status Byte

<u>Bit</u>	<u>Name</u>	<u>Set When</u>
0	Mod Done	No modify function in progress
1	Mod Enable	Modify function enabled
2	User SRQ	User sends a front panel SRQ
3	DDS	An unmasked bit in DDS is set
4	MAV	The gpib output queue non-empty
5	ESB	An unmasked bit in ESB is set
6	RQS/MSS	SRQ (service request) has occurred
7	No Command	No unexecuted commands in the input queue

The DDS and ESB bits are set whenever any unmasked bit (a bit with the corresponding bit in the byte enable register set) in their respective status registers are set. Use DENA and \*ESE commands to set the enable register bits. The DDS and ESB bits are not cleared until **ALL** enabled status bits in DDS and ESB status bytes are cleared (by reading the status bytes or using \*CLS).

#### Using \*STB? to Read the Serial Poll Status Byte

A bit in the Serial Poll Status Byte is NOT cleared by using \*STB?. The bit stays set as long as the status condition exists. This is true even for RQS. RQS will be set whenever the same bit in the Serial Poll Status Byte **AND** Serial Poll enable registers are set. This is independent of whether a serial poll has occurred to clear the service request.

#### Using Serial Poll

Except for SRQ, a bit in the Serial Poll Status Byte is NOT cleared by polling the status byte. When reading the status byte using a serial poll, the RQS bit signals that the DS360 is requesting service. The RQS bit will be set to 1 the first time the DS360 is polled following the service request. The serial poll automatically clears the service request. Subsequent serial polls will return RQS cleared (0) until another service request occurs. Polling the status byte and reading it with \*STB? can return different values for RQS. When serial polled, RQS indicates a service request has occurred. When read with \*STB?, RQS indicates that an enabled status bit is set.

## 4-20 Remote Programming

---

### Standard Event Status Byte

<u>Bit</u>	<u>Name</u>	<u>Set When</u>
0	Unused	
1	Unused	
2	Query Error	Set on output queue overflow
3	Unused	
4	Execution Error	A command cannot be executed (Range Error) (Parameter out of range, command not valid, etc.)
5	Command Error	Command Syntax Error or unrecognized command
6	URQ	Set by any keypress
7	PON	Set by Power ON

This status byte is defined by IEEE-488.2 (1987) and is used primarily to report errors in commands received over the communications interface. The bits in this register stay set and are cleared by reading them using the \*ESR command or by the \*CLS command.

---

### DDS Status Byte

<u>Bit</u>	<u>Name</u>	<u>Set When</u>
0	Trig'd	A burst or sweep is triggered
1	Trig Err	A trigger rate error occurs
2	unused	
3	Adjust Msg	A 2-Tone or Burst parameter is adjusted
4	Warmup	Warm-up period expired
5	Test Error	A self test error occurs
6	Cal Enabled	1 = calibration enabled
7	Mem Error	The stored settings where corrupt

The Warm-up bit will be set and remain set after the warm up period has expired. The rest of the bits in this register are set when the corresponding event occurs and remain set until cleared by reading this status byte (\*ESR) or by the \*CLS command.

## Example Programs

### Using Microsoft C with the National Instruments GPIB card on a PC

To successfully interface the DS360 to a PC via the GPIB interface, the instrument, interface card and interface drivers must all be configured properly. To configure the DS360, the GPIB address must be set in the [SHIFT][GPIB] menu. The default address is 8; use this address unless a conflict occurs with other instruments in your system. The DS360 will be set to GPIB address 8 whenever a reset is performed (power on with the CLR key pressed).

Make sure that you follow all of the instructions for installing the GPIB card. The National Instruments card cannot be simply unpacked and put into your computer. To configure the card, you may need to set jumpers and switches on the card to set the I/O address and the interrupt levels. You must run the program "IBCONF" to configure the resident GPIB driver for your GPIB card. Please refer to the National Instruments manual for more information. In these examples, the following options must be set with IBCONF:

Device Name:	DS360
Device Address:	8
EOS Character:	0Ah (linefeed)
Terminate Read on EOS:	Yes

Once all the hardware and GPIB drivers are configured, use "IBIC". This terminal emulation program allows you to send commands to the DS360 directly from the computer keyboard. If you cannot talk to the DS360 via "IBIC", then your programs will not run.

Use the simple commands provided by National Instruments. Use "IBWRT" and "IBRD" to send and receive from the DS360. After you are familiar with these simple commands, you can explore more complex programming commands.

### Example1: GPIB Communication in C language

```
/*
   C program to demonstrate communication with the DS360 via GPIB.
   Written in Microsoft C and uses National Instruments GPIB card.
   Assumes DS360 is installed as device name DS360.
   Refer to National Instruments for Device Name setup.
*/

#include <stdio.h>
#include <string.h>
#include <stdlib.h>
#include <dos.h>
#include <decl.h>          /* National Instruments header files */

void main(void);
int ds360;

void main()
{
    char cmd[40];
    char start[20];
    char stop[20];

    if ((ds360 = ibfind("DS360")) < 0)          /* open National driver */
    {
        printf ("Cannot find DS360\n");
        exit(1);
    }

    /* Now that the driver is located, reset the DS360 */

    sprintf (cmd,"*RST\n");
    ibwrt(ds360,cmd,strlen(cmd));          /* send command */

    /* Setup the DS360 as follows:
       50kHz,square wave,1.5Vpp, -1.0Volt offset,display offset */

    sprintf (cmd, "FREQ50000";FUNC1;AMPL1.5VP;OFFS-1.5;KEYS8\n");
    ibwrt(ds360,cmd,strlen(cmd));          /* send command */

    /* Now, query the DS360 for the sweep start and stop frequencies */

    sprintf(cmd, "STFR?\n");                /* ask for start freq */
    ibwrt(ds360,cmd,strlen(cm));           /* send query */
    ibrd(ds360,start,20);                  /* read back start freq*/
    sprintf(cmd, "SPFR?\n");                /* ask for stop freq */
    ibwrt(ds360,cmd,strlen(cm));           /* send query */
    ibrd(ds360,stop,20);                   /* read back start freq*/

    printf("\n\n\n\n      **** DS360 Setup Demo ****");
    printf("\n\nDS360 Sweep Start Frequency = %eHz\n\n",atof(start));
    printf("\n\nDS360 Sweep Stop Frequency = %eHz\n\n",atof(stop));
}
}
```



**Example 2: RS232 communication in BASIC language**

BASIC program to demonstrate communication with the DS360 via RS232.  
Program assumes the DS360 BAUD rate is set to 9600.

```

10 OPEN "com2:9600,n,8,2,cs,ds,cd" FOR RANDOM AS #1 ` Setup com2'
20 PRINT #1, " "
30 PRINT #1, "*RST" ` Reset the DS360'
40 GOSUB 190 ` Query DS360 and display result'
50 PRINT #1, "FREQ123456" ` Set new frequency to 123.456kHz'
60 GOSUB 190 ` Query DS360 and display result'
70 PRINT #1, "*RST" ` Reset the DS360'
80 FOR I=0 TO 4 ` Step through all functions `
90 PRINT #1, "FUNC",I
100 GOSUB 190 ` Query DS360 and display result'
110 NEXT I
120 PRINT #1, "*RST" ` Reset the DS360'
130 PRINT #1, "AMPL0VP" ` Set amplitude to 0 volts'
140 FOR I=-5 TO 5 ` Set offset from -5V to 5v'
150 PRINT #1, "OFFS",I ` and query each time'
160 GOSUB 190 ` Query DS360 and display result'
170 NEXT I
180 END

190 PRINT #1, "FREQ?" ` Routine to query the DS360 frequency,'
` amplitude and offset and display them'
200 INPUT #1, F
210 PRINT #1, "AMPL?VP"
220 INPUT #1, A
230 PRINT #1, "OFFS?"
240 INPUT #1, O
250 PRINT "Freq=" ;F; " Ampl="; A; " Offs="; O
260 RETURN

```



---

## Chapter 5

# Performance Tests

The performance tests described in this section are designed to verify with a high degree of confidence that the unit is performing within the specifications.

The results of each test should be recorded on a **copy** of the test sheet located at the end of this section.

### In this Chapter

---

<b>Getting Ready</b>	<b>5-3</b>
Keypad	5-3
Knob	5-3
Reset	5-3
Serial Number	5-3
Firmware Revision	5-3
Necessary Equipment	5-4
Warm-up	5-4
Test Record	5-4
Distortion Measurements	5-5
<b>1. Front Panel Test</b>	<b>5-7</b>
<b>2. Self Tests</b>	<b>5-8</b>
<b>3. Frequency Test</b>	<b>5-9</b>
<b>4. Amplitude Test</b>	<b>5-10</b>
<b>5. Harmonic Distortion</b>	<b>5-13</b>
<b>6. Waveform Test</b>	<b>5-15</b>
<b>7. Sweep Test</b>	<b>5-17</b>
<b>8. Burst Test</b>	<b>5-18</b>
<b>9. DC Offset Test</b>	<b>5-19</b>
<b>10. Output Impedance</b>	<b>5-21</b>
<b>Performance Record</b>	<b>5-23</b>



## Getting Ready

Parameters are set in the DS360 using the front panel keypad or the spin knob. Most parameters can be set directly from the keypad, although it is often more convenient to use the spin knob. Keys are referenced by brackets like this [KEY].

### Keypad

Use the up and down arrow keys [^], [v] to change between functions. To set a parameter, press the the key with the desired parameter on it, ([FREQ] for example, to set the frequency). The current value will be displayed. Most major parameters are labeled on the key itself; minor parameters are labeled above the key in grey. To display these values first press the [SHIFT] key, then the desired key ([SHIFT] [TRIG SRC] to set the trigger source). To change the value, press the appropriate numeric keys, followed by the correct units key. If the value has no particular units, any of the entry keys may be used. If an error is made, press the [CLR] key to return to the current value. If the value entered is outside the allowable limits the DS360 will beep and display an error message.

### Knob

The spin knob can be used to modify most parameters. Display the current value as discribed for the keypad and turn the knob to increment or decrement the parameter. The decade that is being incremented (or decremented) will flash. To change the decade that is being modified, use the left and right cursor keys [< ], [ > ].

### Reset

Throughout this section, it will be necessary to reset the DS360 into a known state. To do this, turn the power off, wait briefly and turn the power back on while holding down the [CLR] key. The unit will perform its power-on self-tests and then assume the default settings. Each test generally starts with a reset.

### Serial Number

If you need to contact Stanford Research Systems, please have the serial number of your unit available. The serial number is printed on a label affixed to the rear panel. It also appears on the display when the unit is first powered on.

### Firmware Revision.

The firmware revision code is displayed on the screen when the unit is first powered on.

### Necessary Equipment

The following equipment is necessary to complete the tests. The suggested equipment or its equivalent may be used.

## 5-4 Performance Tests

---

Instrument	Critical Specification	Recommended Model
Analog Oscilloscope	100 MHz Bandwidth	Tektronix 2252
Time Interval Counter	Time Interval Accuracy: 1 ns Frequency Accuracy: <5ppm	SR620
FFT Spectrum Analyzer	Frequency Range: DC to 100 kHz Amplitude Accuracy +/- 0.1 dB Distortion and Spurious: <80 dB	SR780
DC/AC Voltmeter	5 1/2 Digits DC Accuracy 0.1% AC Accuracy True RMS AC to 100 kHz	HP3458A
Feedthrough Termination	50 $\Omega$ +/- 0.2%, 1 Watt	Any
Notch Filters	100 Hz 1 kHz 20 kHz	Homemade (see the description on <b>Distortion Measurements</b> below)

### Warm Up

The DS360 should be turned on and allowed to warm up for at least an hour before the performance tests are performed. The self tests and functional tests do not require any warm up period.

It is necessary to turn the unit off and on to reset it. As long as the unit is turned back on within a minute, this will not effect the tests results.

### Test Record

Make a copy of the DS360 Performance Test Record at the end of this section. Fill in the results of the tests on this record. The record will allow you to determine whether the unit passes or fails the tests and preserves a record of the tests.

#### If a Test Fails

Check the settings and connections of any external equipment and, if possible, verify its operation using an oscilloscope or other piece of test equipment.

After checking the setup, repeat the test from the beginning to make sure that the test was performed correctly.

If a test continues to fail, contact Stanford Research Systems for further instructions. Make sure that you have the unit serial number and firmware revision number handy. Have the test record on hand as well.

### Distortion Measurements

The notch filters described here are used with a spectrum analyzer for verifying the distortion performance of the DS360. Since there are few, if any, spectrum analyzers with a -120 dB distortion floor, a pre-filter is necessary to attenuate the fundamental frequency and increase the sensitivity to distortion signals. Since the pre-filter attenuates the fundamental component far more than any of the harmonics, the distortion products can be viewed using a spectrum analyzer with a more reasonable -80 dB distortion floor. The figure below shows a “twin-tee” notch filter.

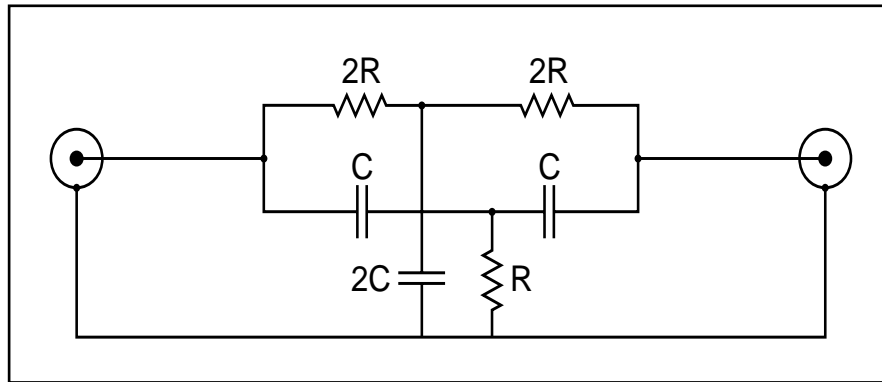

Figure 5-1 Twin-Tee Notch Filter

#### Filter Component Values

<u>Filter Center Frequency</u>	<u>Resistor “R” Value</u>	<u>Capacitor “C” Value</u>
1.0 kHz	7.87 K ± 1%	0.01 μF ± 1%
11.0 kHz	7.15 K ± 1%	0.001 μF ± 1%
31.0 kHz	2.55 K ± 1%	0.001 μF ± 1%

It is important to use high quality resistors and capacitors in the twin-tee notch filter, or distortion measurements will be limited by its performance. Thin film resistors and npo ceramic, or polystyrene capacitors should be used.

The “twin-tee” filter attenuates harmonic components as well as the fundamental, although not nearly as much. The harmonics are attenuated by:

<u>Harmonic</u>	<u>Attenuation</u>
2nd	-9 dB
3rd	-5 dB
4th	-3 dB
5th	-2 dB
>5th	~0 dB

To obtain the true harmonic distortion, these values must be added to the readings obtained from the spectrum analyzer. In addition, the amplitude of the fundamental must be taken into account.

For example, if the 2nd harmonic of a 10 V<sub>RMS</sub> signal is measured at -112 dBV<sub>RMS</sub>, the true value of the 2nd harmonic would be -123 dB (112 dB + 20 dB - 9 dB).

## 5-6 Performance Tests

---

Total harmonic distortion can be calculated from the following formula:

$$T.H.D. (dB) = 20 \log \left( \sqrt{(\log^{-1}(2nd))^2 + (\log^{-1}(3rd))^2 + (\log^{-1}(4th))^2 + \dots + (\log^{-1}(nth))^2} \right)$$

where 2nd, 3rd, 4th, ... nth are the values of the corresponding harmonics in dB relative to the fundamental.



# 1. Front Panel Test

This test verifies the functionality of the front panel display, LED's, keys and knob.

## Setup

No external setup is required.

## Procedure

- 1) Turn on the DS360 while holding down the [FREQ] key. A single segment of the display should light.
- 2) Press the [>] to light each segment (of 7) of the left 2 digits and decimal points. Only one segment should be on at a time. Pressing the [<] key will go back to the previous segment.
- 3) After lighting all seven segments and the decimal point of one digit, all segments and decimal points will light .
- 4) Continue to press the [>] to light each of the LED's on the front panel.They should light one at a time, top to bottom, left to right.
- 5) After all of the LED's have been lit, press each of the front panel keys. Each key will have a unique keycode. Keycodes advance top to bottom, left to right.
- 6) Turn the DS360 off and back on again.
- 7) Turn the spin knob to verify that it modifies the frequency.
- 8) This completes the front panel test. Enter the results of the test oin the test record located at the end of this section.

## 2. Self Tests

This test verifies that the DS360's memory and processors are functional.

### Setup

No external setup is required.

### Procedure

- 1) Turn on the DS360. The ROM firmware version number and the serial number should be displayed for about 3 seconds. The self tests will execute and the message "Tests Pass" should be displayed. If an error message appears, see the **TROUBLESHOOTING** section in **Chapter 3** for a description of the error.
- 2) This completes the self tests. Enter the results of the test on the test record located at the end of this section.

## 3. Frequency

This test measures the frequency accuracy of the DS360.

### Setup

Connect one of the DS360 BNC outputs to the Time Interval Counter. Set the Time Interval Counter to measure frequency with a 1 second gate.

### Procedure

- 1) Reset the DS360 (Turn power off, wait 2 seconds, then turn power on w/ [CLR] pressed).
- 2) Press  
[AMPL][1][0][V<sub>RMS</sub>]  
[FREQ][1][0][0][kHz]
- 3) The frequency value on the Time Interval Counter should read 100.000 kHz  $\pm$  2.5 Hz.
- 4) This completes the frequency accuracy tests. Enter the results of the test on the test record located at the end of this section.

## 4. Amplitude

This test measures the amplitude accuracy of the DS360. For the sine, white noise and pink noise the DVM will be used directly to measure the amplitude. The amplitude for balanced measurements is defined as the voltage between the + and - BNC outputs. Due to the relatively slow rise time of the squarewaves, the DVM cannot be used directly for higher frequency measurements. An initial measurement of the squarewave is made at 100 Hz, where the rise and fall times are inconsequential to the measurement. The amplitude is then measured using the scope to provide an accurate reference for higher frequency measurements.

### Setup

Connect the DS360 + BNC output to the DVM and the scope using a BNC tee. Set the DVM to Vrms, with a long enough integration time to ensure 0.1% accuracy. Connect the DS360 SYNC OUT to the DVM trigger input. Set the DVM to synchronous sub-sampled, external sync (for HP3458A).

### Procedure

- 1) Reset the DS360 (Turn power off, wait 2 seconds, then turn power on w/ [CLR] pressed).
- 2) The sine amplitude accuracy is verified at 1.0 kHz and various amplitudes. For each amplitude, perform steps 2b and 2c.

<u>Voltage (Vrms)</u>	<u>Voltage (Vrms)</u>
14.0	0.4
12.0	0.04
10.0	0.004
7.0	0.00125
4.0	

a) Press

[FREQ][1][kHz]

b) Press

[AMPL][amplitude]

c) Record the amplitude value from the DVM.

- 3) The balanced output amplitude is verified at 4 amplitudes. For each amplitude, perform steps 4c and 4d.

<u>Voltage (Vrms)</u>
8.0
0.8
0.08
0.008

a) Connect the + (red) banana output to the + DVM input. Connect the - (white) banana output to the DVM - input. Connect the common (black) banana to the DVM guard input (if available).

- b) Press  
[ $\checkmark$ ] (output down) to select balanced output.
- c) Press  
[AMPL][*amplitude*]
- d) Record the amplitude value from the DVM.
- 4) The sine amplitude accuracy is verified at 1.0  $V_{RMS}$  and various frequencies. Reconnect the + BNC to the DVM. For each frequency perform steps 5b through 5c.

<u>Frequency</u>	<u>Frequency</u>
10 Hz	2.0 kHz
20 Hz	5.0 kHz
50 Hz	10 kHz
100 Hz	20 kHz
200 Hz	50 kHz
500 Hz	100 kHz
1.0 kHz	200 kHz

- a) Press  
[AMPL][1][ $V_{RMS}$ ]
- b) Press  
[FREQ][*frequency*]
- c) Record the amplitude value from the DVM.
- 5) The anti-aliasing filter (used for sweeps) accuracy is verified at 1.0  $V_{RMS}$ . To do this, the DS360 is set for an externally triggered sweep, with no triggers provided. This causes the stop frequency to be continuously output, which can be measured. For each frequency listed in step 5, perform steps 6b and 6c.
- a) Press  
[SHIFT][TRG SRC]  
Turn the spin knob until Src. Etn (external source) is displayed.  
[START/CENTER][1][Hz]
- b) Press  
[STOP/BW][*frequency*]
- c) Record the amplitude value from the DVM.
- 6) The square amplitude accuracy is verified at 2.0  $V_{PP}$ . For each frequency perform steps 7d through 7e, using the frequencies listed in step 5.
- a) Press [ $\checkmark$ ] to change the function to a squarewave. Set the scope to 0.5V / div.
- b) Press  
[AMPL][2][ $V_{PP}$ ]  
[FREQ][100][Hz]

## 5-12 Performance Tests

---

c) Record the  $V_{\text{RMS}}$  value from the DVM and the  $V_{\text{PEAK-PEAK}}$  value from the scope.

d) Press

[FREQ][frequency]

e) Record the  $V_{\text{PEAK-PEAK}}$  value from the scope.

f) Calculate the flatness using using the minimum (Min) and maximum (Max) values from the peak to peak values.

$$\frac{(Max - Min)}{\left(\frac{Max + Min}{2}\right)} * 100\% = \text{_____} \%$$

7) The white and pink noise amplitude accuracy is verified at a single amplitude level using the DVM. Note that noise signals, especially the pink noise, will vary and require a very long integration time for stable measurements. Set the DVM to analog (non synchronous, no external sync) with an integration time of over 10 seconds.

a) Press

[RCL][0][entry key] to reset the the unit to its default state.

[v][v] to change the function to white noise.

b) Press

[AMPL][1][V<sub>RMS</sub>]

c) Record the amplitude value from the DVM.

d) Press

[v] to change the function to pink noise.

e) Press

[AMPL][1][V<sub>RMS</sub>]

f) Record the amplitude value from the DVM.

8) This completes the amplitude accuracy tests. Enter the results of this test on the test record located at the end of this section.

## 5. Harmonic Distortion and Noise

These tests check the harmonic distortion for sine and square waves.

### Setup

Set the spectrum analyzer input to shield grounded with AC coupling. Obtain the notch filters described on page 5-5.

### Procedure

- 1) Reset the DS360 (Turn power off, wait 2 seconds, then turn power on w/ [CLR] pressed.
- 2) The distortion is verified at 2 amplitudes and 3 frequencies. Set the spectrum analyzer to exponential vector averaging, with 50 averages and  $\text{dBV}_{\text{RMS}}$  units. For each frequency and amplitude setting below, perform 2a through 2d.

<u>Frequency</u>	<u>Span</u>	<u>Input Range (1V<sub>RMS</sub>)</u>	<u>Input Range (10V<sub>RMS</sub>)</u>
1.0 kHz	0 to 12.5 kHz	-36 dBV	-22 dBV
11 kHz	0 to 100 kHz	-36 dBV	-22 dBV
31 kHz	0 to 100 kHz	-36 dBV	-22 dBV

- a) Connect the + output of the DS360 to the Spectrum analyzer through the appropriate filter.
  - b) Set the spectrum analyzer to the appropriate span and input range. Wait for the display to settle.
  - c) Measure the 2nd through 5th harmonics values and calculate the THD (total harmonic distortion) as described in the beginning of the section. Record the THD value on the test record.
  - d) Connect the - output to the notch filter and perform steps 2b and 2c for the - output.
- 3) The residual output noise is verified at the same 2 amplitudes and 3 frequencies as the distortion. Set the spectrum analyzer to measure PSD (power spectral density) with exponential RMS averaging, 50 averages and  $V_{\text{RMS}}$  units. For each frequency and amplitude setting in step 2, perform 3a through 3d.
    - a) Connect the + output of the DS360 to the Spectrum analyzer through the appropriate filter.
    - b) Set the spectrum analyzer to the appropriate span and input range. Wait for the display to settle.
    - c) Measure the noise at non harmonically related points. Avoid frequencies near the fundamental, since they are effected by the notch filter. Record the noise value on the test record.
    - d) Connect the - output to the notch filter and perform steps 3b and 3c for the - output.

## 5-14 Performance Tests

---

- a) Connect the + output of the DS360 directly to the spectrum analyzers input. Set the spectrum analyzer for a 0 to 12.5 kHz span.
  - b) Press  
[V] to select squarewave.  
[AMPL][1][V<sub>RMS</sub>]
  - c) Measure the amplitudes of the even harmonics (2f, 4f ...) relative to the fundamental. Record the largest even harmonic on the test record.
  - d) Change the spectrum analyzer span to 0 to 100kHz.
  - e) Press  
[FREQ][2][0][kHz]
  - f) Measure the amplitudes of the even harmonics relative to the fundamental. Record the largest even harmonic on the test record.
- 5) This completes the harmonic distortion and noise tests.



## 6. Waveforms

These procedures check the various output waveform characteristics.

### Setup

The spectrum analyzer will be used to measure the waveform characteristics of the noise and 2-Tone signals. The oscilloscope will be used to measure rise and fall times of the square wave.

Connect the + BNC output of the DS360 to the spectrum analyzer. Set the spectrum analyzer input to shield grounded with AC coupling.

### Procedure

- 1) Reset the DS360 (Turn power off, wait 2 seconds, then turn power on w/ [CLR] pressed).
- 2) Measure the frequency flatness of the white noise signal. Set the spectrum analyzer to exponential RMS averaging with 500 averages at full span.
  - a) Press  
[▼] (function down) three times to select white noise.  
[AMPL] [1] [V<sub>RMS</sub>]
  - b) Autorange the spectrum analyzer and expand the scale to 1dB.
  - c) Verify that the spectrum lies within 1dB. Record the results on the test record.
- 3) Measure the frequency flatness of the pink noise. Change the spectrum analyzer to octave analysis.
  - a) Press  
[▼] (function down) to select pink noise.  
[AMPL] [1] [V<sub>RMS</sub>]
  - b) Autorange the spectrum analyzer and expand the scale to 1dB.
  - c) Measure the amplitude for the bands from 20 Hz to 20 kHz. This will require several spans.
  - d) Verify that the amplitudes lie within 2dB. Record the results on the test record.
- 4) Measure the IMD (Inter Modulation Distortion) of the 2-Tone signal for 2 different 2-Tone signals.

<u>Tone 1</u>	<u>Tone 2</u>	<u>2T1 + T2</u>	<u>2T1 - T2</u>	<u>2T2 + T1</u>	<u>2T2 - T1</u>
T1=1 kHz, 1V <sub>RMS</sub>	T2=20 kHz, 0.1V <sub>RMS</sub>	22 kHz	-----	41 kHz	39 kHz
T1=10 kHz, 1V <sub>RMS</sub>	T2=12 kHz, 1V <sub>RMS</sub>	32 kHz	8 kHz	34 kHz	12 kHz

- a) Set the spectrum analyzer to measure spectrum, RMS averaging with 10 averages and dBV<sub>RMS</sub> at full span.

## 5-16 Performance Tests

---

b) Press

[V] (function down) to select 2-Tone.  
[FREQ] [1] [kHz]  
[AMPL] [1] [V<sub>RMS</sub>]  
[SHIFT] [T1/T2]  
[FREQ] [2] [0] [kHz]  
[AMPL] [.] [1] [V<sub>RMS</sub>]

c) Span the spectrum analyzer down to measure the IMD products (2T1+T2...) for the first 2-Tone, at the frequencies listed in the table. Record the results on the test record.

d) Press

[SHIFT] [T1/T2]  
[FREQ] [1] [0] [kHz]  
[AMPL] [1] [V<sub>RMS</sub>]  
[SHIFT] [T1/T2]  
[FREQ] [1] [2] [kHz]  
[AMPL] [1] [V<sub>RMS</sub>]

d) Span the spectrum analyzer down to measure the IMD products (2T1+T2...) for the second 2-Tone, at the frequencies listed in the table. Record the results on the test record.

5) The square wave rise time is measured using the scope.

a) Disconnect the DS360 from the spectrum analyzer. Connect the + BNC of the DS360 to CH A of the scope. Set the scope CH A to 2 $\mu$ s/div, 5 V/div, with triggering on CH A.

b) Press

[^] (function up) until square wave is selected.  
[FREQ] [1] [0] [0] [kHz]  
[AMPL] [1] [0] [V<sub>RMS</sub>]

c) Measure the 10% - 90% rise time of the squarewave. Repeat for the fall time. Record the results on the test record.

d) Connect the - BNC of the DS360 to the scope CH A and repeat step 5c) for the - channel.

6) This completes the waveform tests.

## 7. Sweeps

These procedures test the flatness of frequency sweeps.

### Setup

Connect the + BNC of the DS360 to CH A of the scope. Connect the SWEEP OUT BNC from the rear panel of the DS360 to CH B of the scope. Set CH A to 1 V/div, CH B to 5V/div, the time base to 50 $\mu$ s/div and triggering on CH B.

### Procedure

1) Reset the DS360 (Turn power off, wait 2 seconds, then turn power on w/ [CLR] pressed).

2) Measure the sweep flatness for a 1 Hz to 100 kHz sweep.

a) Press

[START/CENTER] [1] [Hz]  
[STOP/BW] [1] [0] [0] [kHz]  
[RATE] [2] [kHz]  
[AMPL] [5] [V<sub>PP</sub>]  
[SWP/BUR]

b) Expand CH A to 0.2 V/div and offset the waveform so the upper portion can be viewed.

Confirm that, excluding the first 10  $\mu$ s, the waveform is flat to within 50 mV<sub>PP</sub> (1/4 of a division). Record the result on the test record located at the end of this section.

3) This completes the sweep test.

## 8. Bursts

These tests measure the accuracy of the burst levels.

### Setup

Connect the + BNC output of the DS360 to the input of the spectrum analyzer. Set the spectrum analyzer to measure spectrum with the input on AC coupling and the shield grounded. Set averaging to exponential RMS with 10 averages. Select  $\text{dBV}_{\text{RMS}}$  for units and set the span to 0-12.5 kHz.

### Procedure

- 1) Reset the DS360 (Turn power off, wait 2 seconds, then turn power on w/ [CLR] pressed).
- 2) Press
  - [ $\nabla$ ] (modify function down) until burst is selected.
  - [SHIFT] [TRG SRC]
    - Select Src. Etn (external source) using the spin knob.
  - [ON/OFF] (SWP/BUR)
  - [AMPL] [1] [0] [ $V_{\text{rms}}$ ]
- 3) Measure the burst amplitude at depths of 100, 10, 1, 0.1 and 0%. At each depth, perform steps 3a) and 3b).
  - a) Press
    - [SHIFT] [DEPTH] [*depth*] [%]
  - b) Measure and record the amplitude on the test record located at the end of this section.
- 4) This completes the waveform tests.

## 9. DC Offset

These tests measure the offset accuracy of the function of the DS360.

### Setup

Connect the positive output of the DS360 to the DVM. Set the DVM to DC volts, auto-ranging. Perform any auto zeroing functions. Set the integration time long enough for 0.1% accuracy.

To make residual offset measurements it is necessary to trigger the DVM from the DS360 sync output to average out the AC waveforms. For these measurements it is necessary to set the integration time longer than that for normal measurements.

### Procedure

- 1) Reset the DS360 (Turn power off, wait 2 seconds, then turn power on w/ [CLR] pressed).
- 2) Verify the offset linearity (DC only) at various points. For each value in the table below, perform 2b) and 2c).

#### Offset Voltage

±20 V<sub>DC</sub>  
 ±2.0 V<sub>DC</sub>  
 ±0.2 V<sub>DC</sub>  
 ±0.02 V<sub>DC</sub>  
 ±0.002 V<sub>DC</sub>

- a) Press  
     [AMPL] [0] [V<sub>DC</sub>]
- b) Press [OFFST] [*offset*] [V<sub>DC</sub>]
- c) Measure the output voltage on the DVM. Record the results on the test record.

- 3) Measure the residual offset (0 V) for different amplitudes. For each amplitude listed in the table below, perform steps 3c and 3d.

#### Test Amplitudes

10 V<sub>RMS</sub>  
 1.0 V<sub>RMS</sub>  
 0.1 V<sub>RMS</sub>  
 0.01 V<sub>RMS</sub>  
 0.001 V<sub>RMS</sub>

- a) Connect the SYNC BNC from the DS360 to the trigger input of the DVM. Set the integration time to at least 1 second.
- b) Press  
     [OFFST] [0] [V<sub>DC</sub>]
- c) Press  
     [AMPL] [*amplitude*] [V<sub>DC</sub>]

- d) Measure the output voltage on the DVM. Record the results.
- 4) Measure the residue offset ( $0 V_{DC}$ ) for square waves, white noise and pink noise.
- a) Press  
[ $\nabla$ ] (function down) to select square waves.  
[AMPL] [1] [ $V_{RMS}$ ]
  - b) Measure the output voltage on the DVM. Record the results.
  - c) Disconnect the sync signal from the DS360 to the DVM. Set the integration time to the longest possible, to ensure accurate DC measurements of the noise signals.
  - d) Press  
[ $\nabla$ ] (function down) to select white noise.  
[AMPL] [1] [ $V_{RMS}$ ]
  - e) Measure the output voltage on the DVM. Record the results.
  - f) Press  
[ $\nabla$ ] (function down) to select pink noise.  
[AMPL] [1] [ $V_{RMS}$ ]
  - g) Measure the output voltage on the DVM. Record the results.
- 5) This completes the offset tests.

## 10. Output Impedance

These tests confirm the output source resistors of the DS360.

### Setup

Connect the + BNC output of the DS360 to the DVM through the 50  $\Omega$  feed through terminator. Set the DVM to AC volts, auto-ranging.

### Procedure

- 1) Reset the DS360 (Turn power off, wait 2 seconds, turn power on w/ [CLR] pressed).
- 2) Measure the output voltage for Hi-Z output impedance and record the results on the test record.
- 3) Measure the output voltage for 600  $\Omega$  (unbalanced) output impedance.
  - a) Press  
[SHIFT] [600]  
[AMPL] [1] [V<sub>RMS</sub>]
  - b) Measure and record the output voltage on the test record.
- 4) Measure the output voltage for 50  $\Omega$  (unbalanced) output impedance.
  - a) Press the following keys  
[SHIFT] [50]  
[AMPL][1][V<sub>rms</sub>]
  - b) Measure and record the output voltage on the test record.
- 4) Measure the output voltage for 600  $\Omega$  (balanced) output impedance.
  - a) Press the following keys  
[ $\nabla$ ] (output down) for balanced impedance.  
[SHIFT][600]  
[AMPL][1][V<sub>rms</sub>]
  - b) Measure and record the output voltage on the test record.
- 5) Measure the output voltage for 150  $\Omega$  (balanced) out with a 50  $\Omega$  terminator.
  - a) Press the following keys  
[SHIFT][150]  
[AMPL][1][V<sub>rms</sub>]
  - b) Measure and record the output voltage on the test record.

## 5-22 Performance Tests

---

- 7) Disconnect the + BNC output from the DVM. Connect the - BNC output to the DVM. Repeat steps 1 through 5.
- 8) Confirm the output on/off function operates
  - a) Press  
[ON/OFF] (output on/off)
  - b) Confirm that the DVM reads 0 (or nearly zero).
- 9) This completes the offset tests.



# DS360 Performance Test Record

Page 1 of 4

Serial Number \_\_\_\_\_ Tested By \_\_\_\_\_

Firmware Revision \_\_\_\_\_ Date \_\_\_\_\_

Equipment Used \_\_\_\_\_  
 \_\_\_\_\_

## 1. Front Panel

<u>Test</u>	<u>Pass</u>	<u>Fail</u>
Display	_____	_____
Keypad	_____	_____
Knob	_____	_____

## 2. Self Test

<u>Test</u>	<u>Pass</u>	<u>Fail</u>
Self Tests	_____	_____

## 3. Frequency

	<u>Set Value</u>	<u>Lower Limit</u>	<u>Frequency</u>	<u>Upper Limit</u>
	100.000 kHz	99.9975 kHz	_____	100.0025 kHz

## 4. Amplitude Accuracy

	<u>Set Voltage</u>	<u>Lower Limit</u>	<u>+ Output</u>	<u>Upper Limit</u>
Unbalanced Attenuator Test	14.0 V <sub>RMS</sub>	13.86 V <sub>RMS</sub>	_____	14.14 V <sub>RMS</sub>
	12.0 V <sub>RMS</sub>	11.88 V <sub>RMS</sub>	_____	12.12 V <sub>RMS</sub>
	10.0 V <sub>RMS</sub>	9.90 V <sub>RMS</sub>	_____	10.10 V <sub>RMS</sub>
	7.0 V <sub>RMS</sub>	6.93 V <sub>RMS</sub>	_____	7.07 V <sub>RMS</sub>
	4.0 V <sub>RMS</sub>	3.96 V <sub>RMS</sub>	_____	4.04 V <sub>RMS</sub>
	0.40 V <sub>RMS</sub>	0.396 V <sub>RMS</sub>	_____	0.404 V <sub>RMS</sub>
	0.04 V <sub>RMS</sub>	0.0396 V <sub>RMS</sub>	_____	0.0404 V <sub>RMS</sub>
	0.004 V <sub>RMS</sub>	0.00396 V <sub>RMS</sub>	_____	0.00404 V <sub>RMS</sub>
	0.00125 V <sub>RMS</sub>	0.001238 V <sub>RMS</sub>	_____	0.001263 V <sub>RMS</sub>

	<u>Set Voltage</u>	<u>Lower Limit</u>	<u>Output</u>	<u>Upper Limit</u>
Balanced Attenuator Test	8.0 V <sub>RMS</sub>	7.92 V <sub>RMS</sub>	_____	8.08 V <sub>RMS</sub>
	0.80 V <sub>RMS</sub>	0.792 V <sub>RMS</sub>	_____	0.808 V <sub>RMS</sub>
	0.08 V <sub>RMS</sub>	0.0792 V <sub>RMS</sub>	_____	0.0808 V <sub>RMS</sub>
	0.008 V <sub>RMS</sub>	0.00792 V <sub>RMS</sub>	_____	0.00808 V <sub>RMS</sub>

	<u>Frequency</u>	<u>Lower Limit</u>	<u>Output</u>	<u>Upper Limit</u>
Sinewave Flatness	10 Hz	0.99 V <sub>RMS</sub>	_____	1.01 V <sub>RMS</sub>
	20 Hz	0.99 V <sub>RMS</sub>	_____	1.01 V <sub>RMS</sub>
	50 Hz	0.99 V <sub>RMS</sub>	_____	1.01 V <sub>RMS</sub>
	100 Hz	0.99 V <sub>RMS</sub>	_____	1.01 V <sub>RMS</sub>
	200 Hz	0.99 V <sub>RMS</sub>	_____	1.01 V <sub>RMS</sub>
	500 Hz	0.99 V <sub>RMS</sub>	_____	1.01 V <sub>RMS</sub>

**DS360 Performance Test Record**

**4. Amplitude Accuracy (Continued)**

	1.0 kHz	0.99 V <sub>RMS</sub>	_____	1.01 V <sub>RMS</sub>	
	2.0 kHz	0.99 V <sub>RMS</sub>	_____	1.01 V <sub>RMS</sub>	
	5.0 kHz	0.99 V <sub>RMS</sub>	_____	1.01 V <sub>RMS</sub>	
	10 kHz	0.99 V <sub>RMS</sub>	_____	1.01 V <sub>RMS</sub>	
	20 kHz	0.99 V <sub>RMS</sub>	_____	1.01 V <sub>RMS</sub>	
	50 kHz	0.99 V <sub>RMS</sub>	_____	1.01 V <sub>RMS</sub>	
	100 kHz	0.99 V <sub>RMS</sub>	_____	1.01 V <sub>RMS</sub>	
	200 kHz	0.99 V <sub>RMS</sub>	_____	1.01 V <sub>RMS</sub>	
Antialiasing Filter Amplitude	<u>Frequency</u>	<u>Lower Limit</u>	<u>Output</u>	<u>Upper Limit</u>	
	10 Hz	0.99 V <sub>RMS</sub>	_____	1.01 V <sub>RMS</sub>	
	20 Hz	0.99 V <sub>RMS</sub>	_____	1.01 V <sub>RMS</sub>	
	50 Hz	0.99 V <sub>RMS</sub>	_____	1.01 V <sub>RMS</sub>	
	100 Hz	0.99 V <sub>RMS</sub>	_____	1.01 V <sub>RMS</sub>	
	200 Hz	0.99 V <sub>RMS</sub>	_____	1.01 V <sub>RMS</sub>	
	500 Hz	0.99 V <sub>RMS</sub>	_____	1.01 V <sub>RMS</sub>	
	1.0 kHz	0.99 V <sub>RMS</sub>	_____	1.01 V <sub>RMS</sub>	
	2.0 kHz	0.99 V <sub>RMS</sub>	_____	1.01 V <sub>RMS</sub>	
	5.0 kHz	0.99 V <sub>RMS</sub>	_____	1.01 V <sub>RMS</sub>	
	10 kHz	0.99 V <sub>RMS</sub>	_____	1.01 V <sub>RMS</sub>	
	20 kHz	0.99 V <sub>RMS</sub>	_____	1.01 V <sub>RMS</sub>	
	50 kHz	0.99 V <sub>RMS</sub>	_____	1.01 V <sub>RMS</sub>	
	100 kHz	0.99 V <sub>RMS</sub>	_____	1.01 V <sub>RMS</sub>	
	200 kHz	0.99 V <sub>RMS</sub>	_____	1.01 V <sub>RMS</sub>	
Squarewave Amplitude	<u>Frequency</u>	<u>Amplitude</u>	<u>Lower Limit</u>	<u>Output</u>	<u>Upper Limit</u>
	100 Hz	2 V <sub>PP</sub>	1.98 V <sub>PP</sub>	_____	2.02 V <sub>PP</sub>
			0.99 V <sub>RMS</sub>	_____	1.01 V <sub>RMS</sub>
Squarewave Flatness	<u>Frequency</u>	<u>Output</u>		<u>Frequency</u>	<u>Output</u>
	10 Hz	_____		2.0 kHz	_____
	20 Hz	_____		5.0 kHz	_____
	50 Hz	_____		10 kHz	_____
	100 Hz	_____		20 kHz	_____
	200 Hz	_____		50 kHz	_____
	500 Hz	_____		100 kHz	_____
	1.0 kHz	_____		200 kHz	_____
Flatness Calculation	<u>Min Outout</u>	_____	<u>Max Output</u>	_____	<u>Upper Limit</u>
	Flatness		Lower Limit	_____	Upper Limit
			99%	_____	101%
Noise Amplitude		<u>Amplitude</u>	<u>Lower Limit</u>	<u>Output</u>	<u>Upper Limit</u>
	White Noise	1.00 V <sub>RMS</sub>	0.98 V <sub>RMS</sub>	_____	1.02 V <sub>RMS</sub>
	Pink Noise	1.00 V <sub>RMS</sub>	0.96 V <sub>RMS</sub>	_____	1.04 V <sub>RMS</sub>

DS360 Performance Test Record						Page 3 of 4	
<b>5. Harmonic Distortion</b>							
Sine Wave	<u>Frequency</u>	<u>Amplitude</u>	<u>+ Output</u>	<u>- Output</u>	<u>Upper Limit</u>		
Distortion	1 kHz	1.0 V <sub>RMS</sub>	_____	_____	-106 dB		
	1 kHz	10.0 V <sub>RMS</sub>	_____	_____	-105 dB		
	11 kHz	1.0 V <sub>RMS</sub>	_____	_____	-100 dB		
	11 kHz	10.0 V <sub>RMS</sub>	_____	_____	-99 dB		
	31 kHz	1.0 V <sub>RMS</sub>	_____	_____	-96 dB		
	31 kHz	10.0 V <sub>RMS</sub>	_____	_____	-93 dB		
Sinewave	<u>Frequency</u>	<u>Amplitude</u>	<u>+ Output</u>	<u>- Output</u>	<u>Upper Limit</u>		
Broad Band Noise	1 kHz	1.0 V <sub>RMS</sub>	_____	_____	150 nV $\sqrt{\text{Hz}}$		
	1 kHz	10.0 V <sub>RMS</sub>	_____	_____	150 nV $\sqrt{\text{Hz}}$		
	11 kHz	1.0 V <sub>RMS</sub>	_____	_____	150 nV $\sqrt{\text{Hz}}$		
	11 kHz	10.0 V <sub>RMS</sub>	_____	_____	150 nV $\sqrt{\text{Hz}}$		
	31 kHz	1.0 V <sub>RMS</sub>	_____	_____	150 nV $\sqrt{\text{Hz}}$		
	31 kHz	10.0 V <sub>RMS</sub>	_____	_____	150 nV $\sqrt{\text{Hz}}$		
Square Wave	<u>Frequency</u>	<u>Amplitude</u>		<u>Max Even</u>	<u>Upper Limit</u>		
Even Harmonics	1 kHz	1.0 V <sub>RMS</sub>		_____	-60 dB		
	20 kHz	1.0 V <sub>RMS</sub>		_____	-60 dB		
<b>6. Waveform</b>							
Noise Flatness					<u>Upper Limit</u>		
		White Noise		_____	1 dB		
		Pink Noise		_____	2 dB		
2-Tone IMD	<u>T1</u>	<u>T2</u>	<u>2T1+T2</u>	<u>2T1-T2</u>	<u>2T2+T1</u>	<u>2T2-T1</u>	<u>Upper Limit</u>
	1k,1V	20k,1V	_____	-----	_____	_____	-80dB
	10k,1V	12k,1V	_____	_____	_____	_____	-80dB
Square Wave $T_r, T_f$	<u>Frequency</u>	<u>Amplitude</u>	<u>Rise Time</u>	<u>Fall Time</u>	<u>Upper Limit</u>		
+ Output	100 kHz	10 V <sub>RMS</sub>	_____	_____	1.3 $\mu\text{s}$		
- Output	100 kHz	10 V <sub>RMS</sub>	_____	_____	1.3 $\mu\text{s}$		
<b>7. Sweeps</b>							
<u>Sweep Flatness</u>					<u>Upper Limit</u>		
				_____	50 mV <sub>PP</sub>		
<b>8. Bursts</b>							
		<u>Off Level</u>	<u>Lower Limit</u>	<u>Amplitude</u>	<u>Upper Limit</u>		
		100%	19.0 dBV <sub>RMS</sub>	_____	21.0 dBV <sub>RMS</sub>		
		10 %	-1.0 dBV <sub>RMS</sub>	_____	+1.0 dBV <sub>RMS</sub>		
		1 %	-21.0 dBV <sub>RMS</sub>	_____	-19.0 dBV <sub>RMS</sub>		
		0.1 %	-42.0 dBV <sub>RMS</sub>	_____	-38.0 dBV <sub>RMS</sub>		
		0.0 %	-----	_____	-60 dBV <sub>RMS</sub>		

## DS360 Performance Test Record

Page 4 of 4

## 9. DC Offset

Offset Linearity	Set Value	Lower Limit	Offset	Upper Limit
	+20 V <sub>DC</sub>	19.775 V <sub>DC</sub>	_____	20.225 V <sub>DC</sub>
	+2.0	1.955 V <sub>DC</sub>	_____	2.045 V <sub>DC</sub>
	+0.2	0.1955 V <sub>DC</sub>	_____	0.2045 V <sub>DC</sub>
	+0.02	19.55 mV <sub>DC</sub>	_____	20.45 mV <sub>DC</sub>
	+0.002	1.905 mV <sub>DC</sub>	_____	2.095 mV <sub>DC</sub>
	-20 V <sub>DC</sub>	-19.775 V <sub>DC</sub>	_____	-20.225 V <sub>DC</sub>
	-2.0	-1.955 V <sub>DC</sub>	_____	-2.045 V <sub>DC</sub>
	-0.2	-0.1955 V <sub>DC</sub>	_____	-0.2045 V <sub>DC</sub>
	-0.02	-19.55 mV <sub>DC</sub>	_____	-20.45 mV <sub>DC</sub>
	-0.002	-1.905 mV <sub>DC</sub>	_____	-2.095 mV <sub>DC</sub>
<u>Waveform</u>	<u>Amplitude</u>	<u>Lower Limit</u>	<u>Offset</u>	<u>Upper Limit</u>
Sine	10 V <sub>RMS</sub>	-166 mV <sub>DC</sub>	_____	+166 mV <sub>DC</sub>
Sine	1.0 V <sub>RMS</sub>	-39.1 mV <sub>DC</sub>	_____	+39.1 mV <sub>DC</sub>
Sine	0.10 V <sub>RMS</sub>	-3.91 mV <sub>DC</sub>	_____	+3.91 mV <sub>DC</sub>
Sine	0.010 V <sub>RMS</sub>	-391 $\mu$ V <sub>DC</sub>	_____	+391 $\mu$ V <sub>DC</sub>
Sine	0.001 V <sub>RMS</sub>	-64 $\mu$ V <sub>DC</sub>	_____	+64 $\mu$ V <sub>DC</sub>
Square	1.0 V <sub>RMS</sub>	-35 mV <sub>DC</sub>	_____	+35 mV <sub>DC</sub>
White Noise	1.0 V <sub>RMS</sub>	-60 mV <sub>DC</sub>	_____	+60 mV <sub>DC</sub>
Pink Noise	1.0 V <sub>RMS</sub>	-240 mV <sub>DC</sub>	_____	+240 mV <sub>DC</sub>

## 10. Output Impedance

Impedance	Amplitude	Lower Limit	+ Output	Upper Limit
Hi-Z	1.0 V <sub>RMS</sub>	0.632 V <sub>RMS</sub>	_____	0.701 V <sub>RMS</sub>
600 Unbal	1.0 V <sub>RMS</sub>	0.151 V <sub>RMS</sub>	_____	0.157 V <sub>RMS</sub>
50 Unbal	1.0 V <sub>RMS</sub>	0.958 V <sub>RMS</sub>	_____	1.040 V <sub>RMS</sub>
600 Bal	1.0 V <sub>RMS</sub>	0.140 V <sub>RMS</sub>	_____	0.145 V <sub>RMS</sub>
150 Bal	1.0 V <sub>RMS</sub>	0.387 V <sub>RMS</sub>	_____	0.413 V <sub>RMS</sub>
Output On/Off		Pass	_____	

## Chapter 6

# Circuit Description

This chapter provides descriptions of the circuitry of the DS360. Each boards description and function is discussed. The schematics and parts list are shown at the end of the chapter.

## In this Chapter

<b>Overview</b>	<b>6-3</b>
<b>Digital Board Description</b>	<b>6-3</b>
DSP and Control Logic	6-3
Burst Control	6-3
Microprocessor and System Clocks	6-4
Front Panel Control	6-5
GPIB and RS232	6-5
Power Supply	6-5
<b>Analog Board Description 7-6</b>	
Digital-Analog Interface	6-6
Waveform Generation	6-6
Distortion Reduction Filters	6-6
Amplitude and Offset Control	6-7
Output Amplifier	6-7
Attenuators and Source Resistors	6-8
Power Supply	6-8
<b>Front Panel Description</b>	<b>6-9</b>
Display Board	6-9
Output Board	6-9
<b>Programmable Resistor Board</b>	<b>6-9</b>
<b>Digital Board Parts List</b>	<b>6-11</b>
<b>Analog Board Parts List</b>	<b>6-15</b>
<b>Front Panel Parts List</b>	<b>6-27</b>
<b>Distortion Filter Parts List</b>	<b>6-31</b>
<b>Miscellaneous and Chassis Parts List</b>	<b>6-32</b>
<b>Digital Board Schematics</b>	<b>DIG-1 to DIG-7</b>
<b>Analog Board Schematics</b>	<b>ANA-1 to ANA-7</b>
<b>Front Panel Schematics</b>	<b>FP-1 and FP-2</b>
<b>Programmable Resistor Board Schematics</b>	<b>PROGR1</b>



## Overview

The DS360's circuitry is divided into two major sections: the digital section and the analog section. The digital section contains the controlling microprocessor, communications interfaces, front panel control and digital signal processor. The analog section contains the analog to digital converter, waveform conditioning circuitry, amplifiers and attenuators. In addition there are four other boards: the front panel display board, the front panel output board and two switchable resistor boards.

## Digital Board

This section covers schematics DIG-1 through DIG-7 at the end of this section.

The digital board contains the main CPU, system memory, external interfaces including the front panel, RS-232 and GPIB, the digital signal processor and its memory, timing and control logic and the digital power supply.

### DSP and Control Logic

U101 is a Motorola DSP56002FC40, a 24 bit fixed point, digital signal processor. It is capable of performing a multiply and two register moves in a single 53 ns cycle. The DSP56002 has 512 words of internal data RAM, and 512 words of program RAM. There is also two internal ROM tables, a 256 word sine table and a 256 word A/Mu Law table (not used in the DS360). There is a single external data bus, which is multiplexed into three sections, X and Y data memory and P program memory. U102, U103 and U104 (32k \* 8) make up the DSP memory. U114 segments the memory into the X, Y, and P sections.

The DSP56002 contains an internal PLL (phase lock loop) that multiplies the system clock (see DIG-4) of 5.3 MHz up to 18.9 MHz internally. Communications with the main processor take place via the Host Port (U101 H0-H7, HA0-HA2, HR/W, HEN).

Data is sent from the DSP to the D/A converter through parallel to serial converters (U105-U107) (74HC597), on the DSP memory bus. These signals are synchronized to the system clock before passing to the analog board through J101. U111 and U112 generate the data clocking and frame sync signals.

U109 generates output control signals from the DSP data and address lines. U115 and U116 synchronize status information to the output data. U110 generates clocking and sync signals for the digital output. Communications between the DSP56002 and digital output are via the serial output (STD, SCK) and the U108 port.

### Burst Control

U301 and U302 are PAL's that generates the rate and width clocking signals for the synchronous bursts. U303 (8254) is a triple 16 bit counter used to generate burst rates, burst widths and clocking for noise signals. U306 and U307 (74HC74) are used to synchronize external events to the burst clock. U308 contains all of the processor control signals for bursts.

### Microprocessor and System Clocks

U401 is a Z80 general purpose microprocessor. It is clocked at 10.6 MHz, generated from the main system clock. The 16 bit address space (A0-A15), is divided into ROM (U402) and RAM (U403) by U413. The memory map for ROM and RAM is as follows:

ROM	\$0000 to \$CFFF
RAM	\$D000 to \$FFFF

U407 (74HC154) generates all chip selects for the system. U404 and U406 are system status and control ports, respectively. U416 is the digital output control port (for U201). U415-A or's together all of interrupt signals to generate the maskable interrupt to the Z80.

U405 (8254) is a triple 16 bit counter, used to generate the real time clock (1.67 ms), set the RS232 baud rate (for U604) and speaker tones (for SP401). The baud rate can range from 300 to 19.2k baud. D401, D402, and BT101 provide the battery backup to the system RAM (U403). Q402, Q403 and associated resistors and capacitors generate the power on reset and power fail shut down.

U408 is a 32.333 MHz 25 ppm oscillator. It is buffered by U411 to three different paths, the system clocks, DSP control logic and D/A sync control. This is to avoid any signal contamination due to reflections or load variations. The main clock is divided down by U409 and U410 to provide the different system clocks.



### Front Panel Control

The front panel display board consists of eight 7 segment displays and 50 discrete LEDs. They are arranged into eight groups, each driven by a strobe line. U501 and U502 are the latch and drivers for the strobes. U503 and N501 are pull down latches and current limiting resistors for the seven segment displays. U505, U506, N504, R502 and R503 are latches, pull down transistors and current limiting resistors for the discrete LED's. U507 is the keypad input. U508 and U509 decode the direction that the knob is turning and generate the knob interrupt to the main processor. U504 (74HC4538) acts as a watchdog timer, shutting off the LEDs if the processor stops working.

### GPIB & RS232

The GPIB (IEEE-488) interface is provided by U601, a NAT9914 controller. U602 (75160A) and U603 (75161A) buffer the data and control lines to the GPIB connector. U601 is programmed to provide an interrupt to the processor whenever there is bus activity addressed to the unit.

The 8251 UART (U604) provides all the UART functions, except the baud rate (generated by U405). U605 (MAX202) provides level shifting and buffering for incoming and outgoing data. U604 generates an interrupt whenever there is activity over the RS232 interface.

The RS232 port is a DCE and may be connected to a PC using a standard serial cable (not a "null modem" cable).

### Power Supply

---

#### CAUTION

Dangerous voltages are present on the printed circuit board when the instrument is attached to the power source, **even if the unit is turned off!** Always wait at least one minute after removing the power before opening the unit.

---

The power entry module provides a connection to the power source, fuses the line, selects the line voltage and filters out high frequencies noise. SW701 switches the line and neutral. Transformer T701 provides all low voltage power to both the digital and analog boards.

D701 and D702 rectify the low AC voltage for the digital section. U701 (LM7805) is a three terminal regulator that provides +5 V<sub>DC</sub> for most of the digital circuitry. U702 (LM7805) provides +5 V<sub>DC</sub> for the LEDs and displays. U703 (LM317L) provides +7 V<sub>DC</sub> for the cooling fan.

## Analog Board

This section covers schematics ANA-1 through ANA-7 at the end of this chapter.

The analog board contains the interface logic to the digital board, the waveform DAC, all signal conditioning circuitry, attenuators, amplifiers and analog power supplies.

### Digital - Analog Interface

U101, U102 and U103 (HCPL-7100) are low jitter opto-isolators that transmit the serial waveform data from the DSP to the waveform DAC. The interface consists of the data, clock for the data, and a frame sync signal to load the DAC.

U106, U107 and U108 (6N137) are opto-isolators that transmit control signals from the main processor to the analog board. 16 bits of data is clocked into shift registers U109 and U110 (74HC164) whenever any parameter is changed on the analog board. The three highest bits (first 3 bits clocked in) go to U111 (74HC138), which provides chip selects for the various devices.

U112 (6N137) is used to control the burst logic. U114 (HCPL-7100) is the sync signal that is used on the digital board.

### Waveform Generation

The waveform DAC is used to generate all output waveforms. To generate sine waves, white noise, sweeps or 2-Tones, relay K201 selects the output of the anti-imaging filter directly. For pink noise, the waveform DAC generates white noise, which is filtered into pink noise by U207 (LF357) and its associated resistors and capacitors. Relay K201 then selects the output of U207. Square waves are generated by using a comparator to sense zero crossings of a sine wave. They are switched into the circuit on ANA-4.

The waveform DAC is an Analog Devices AD1862-J, a 20 bit, ultra low distortion DAC, capable of generating a sine wave with  $< -100\text{dBc}$  THD (total harmonic distortion). U202 (AD797) is its associated current to voltage converter. They feed a seventh order Cauer anti-imaging filter which filters out any out of band frequency components.

The heart of the square wave and sync generator is the high speed analog comparator, U209 (LT1016). The sine wave is buffered and amplified by U208A (LF412) to ensure that the comparator operates over all input signal levels. Low frequency hysteresis is provided by U210 (LM311) and U113A. High frequency hysteresis is provided by C222.

The output of the LT1016 is raised to full TTL (0 to  $+5 V_{\text{DC}}$ ) by U113B. When selected by relay K202, this signal is amplified by U208B (LF412) to  $\pm 6.5 V_{\text{PP}}$ .

P201 is the low frequency square wave phase adjust that sets the square wave symmetry. C225 controls the rise time of the square wave.

### Distortion Reduction Filters

There are two cascaded programmable distortion reduction filters. These operate by attenuating the distortion products ( $2 * F_o$ ,  $3 * F_o$  ...) without affecting the fundamental

signal. Each filter is a second order, state variable, low pass filter. J301 and J302 are connected to switchable resistor networks.

The filters are programmed within a decade by varying the resistors on J301 and J302. There are 9 steps per decade, set by R0 - R5 (U309). Decades are set by changing capacitors C301 - C304 and C317 - C320 with relays K301, K302, K304, K305. The resistor and capacitor settings are always the same for both filters.

The filters can be bypassed for certain situations by relay K303. U308 provides additional gain before the signal passes through the attenuators.

### **Amplitude and Offset Control**

U401, U402, U403 and U404 is the burst circuitry. When bursts are active, the dual DAC U401 (AD7549) sets the “on” and “off” levels for bursts. U403 A and B (OP-275) are current to voltage converters for U401. U404 (DG444) selects between the two levels, based on a signal from the digital board. U402 (OP-275) acts as input and output buffers. P401 removes any DC offset voltage between the “on” and “off” levels.

Relay K407 selects either square waves or all other signals. Relay K405 switches the burst DACs in or out.

Relays K401, K402, K403, K404, K406 and their associated resistors make up a 1 k $\Omega$  pre-attenuator chain. All or none of the attenuators may be switched in, depending on the output amplitude.

U405 (REF02) is a low drift +5.00 V<sub>DC</sub> reference. Its output is filtered by L401 and C404 to reduce its output noise. DAC U406 (AD7542) and U407 (NE5532) set the offset voltage from -5.00 to +5.00 V<sub>DC</sub>.

### **Output Amplifiers**

There are two independent output amplifiers. Each has a separate pre-amplifier. U501 (AD797) provides a gain of +1.6 to the upper amplifier. U504 (AD797) provides a gain of -1.6 to the lower amplifier. P506 is used to balance the upper and lower amplifiers. U502 and U505 (NE5534) provide a low frequency DC stabilization loop for the two output amplifiers. They adjust the non-inverting inputs of the output amplifiers to maintain the correct DC voltage at the outputs. P503 balances the DC output voltage between the two.

#### **Discrete Amplifiers**

The two amplifiers are identical. For simplicity’s sake, only the upper amplifier will be described.

The output amplifiers are essentially discrete op-amps. U503-5 is the inverting input, U503-2 is the non-inverting input and the junction between R527 and R528 is the output. The amplifiers are connected in an inverting configuration, with R507 the input resistor, and R511 and P501 the feedback resistor. The non-inverting input is grounded through R515. C503 provides feedback compensation, to prevent oscillations.

U503 (MAT-02) is a dual, low noise transistor, that is used as a differential amplifier. Q505 is a current source, which draws a constant 1.6 mA (0.8 mA through each leg of

U503). Q503, Q504 and Q506 are configured as a cascode, to maintain a constant voltage across U503. Q501 and Q502 are active collector loads for U503 A and B. Q507 provides a low impedance source to Q508, which provides most of the voltage gain. It is biased at 3.5 mA by Q509.

Output transistors Q512 and Q513 are configured as a class B amplifier (push-pull). However, Q510 and Q511 bias them slightly on, to reduce crossover distortion. P502 sets the bias current through Q512 and Q513.

### Output Attenuators and Source Resistance

Relay K601 can select the + and - signals for normal operation, or ground for switching the outputs off. Relays K602, K603 and K604 select output attenuation of 0dB, 20dB, 40dB or 60dB for both the + and - outputs. The attenuator chain has an output resistance of 25 $\Omega$ . Relays K605, K606 and K607 select an additional resistance, that together with the attenuator output resistance, provides the desired source resistance.

U601, U603, U606, U608, U610 are latches for most of the relays in the analog section. U602, U604, U605, U607, U609, Q601, Q602 and Q603 are drivers for all relays. All relays are latching type, so the drivers output a brief +5 V pulse (~4 ms) to set or clear each relay.

### Power Supply

The analog board is floating relative to the chassis or the digital board. It is AC coupled to ground through C790-C796 and R705 on the analog board. There is additional coupling on the output board.

J701 brings power from the main transformer to the analog board. D701, D702 rectify the AC voltages into unregulated DC voltages that are filtered by C703-C706 and C719-C722. U701 (LM317) and U702 (LM337) are adjustable voltage regulators, programmed for  $\pm 28$  V<sub>DC</sub>. L701-L704 and C711-C718 provide high frequency filtering for the output voltage. U703 (LM7815) and U704 (LM7915) are fixed  $\pm 15$  V<sub>DC</sub> voltage regulators. Their outputs are filtered by L705-L708 and C725-C732.

U705 (LM7805) provides +5 V<sub>DC</sub> to most of the logic circuitry on the analog board. U709 (LM7805) and U707 (LM7905) provide  $\pm 5$  V<sub>DC</sub> to the square wave circuitry. R706 and R707 are dropping resistors, to minimize the power dissipated in U709 and U707. U706 (LM78L12) and U708 (LM79L12) provide power to the waveform DAC.

C741-C749 are bypass capacitors for the +5 V logic (U705). C755-C759 are bypass for the square wave +5 V (U709). C770-C775 are bypass for +28 V. C780-C785 are bypass for -28 V. C776-C777 are bypass for +15 V. C786-C787 are bypass for -15 V.

## Front Panel

This section covers schematic FP-1 and FP-2 at the end of this chapter.

### Display Board

The front panel display board consists of eight 7 segment displays, 50 discrete LEDs, the keypad and the spin knob.

The front panel uses a multiplexed scheme to minimize the number of conductors required to drive it. The 7 segment displays and LEDs are divided into eight sections, each driven by a strobe line. All of the displays share a common pull down (Da-Dg, Ddp) and the LEDs have 7 shared pull downs (LED0-LED6). When a strobe line is hi, that display is active, with the displayed segments determined by the display pulldowns. The LEDs that share that strobe line are also active, controlled by the LED pulldowns. This is repeated for each of the strobes in turn.

While a strobe line is high, the keyboard port (KEY0-KEY4) is able to read the keys on that strobe.

The spin knob is an optical encoder. Each transition of its quadrature outputs is clocked into circuitry on the digital board. The main processor keeps track of the knobs direction and speed.

### Output Board

The output board provides connections and filtering for the front panel outputs on the DS360. The + output and - output are brought from the analog board on RG174 cable. There is additional coupling from the analog board common to the chassis ground on this board from R1 and C5-C8.

## Programmable Resistor Board

This section covers schematic PROGR-1 at the end of this chapter.

This board is a dual programmable resistor. Individual resistors are selected by control lines R0-R5. Any combination of resistors can be selected (32 possibilities), however only nine of them are used in the DS360 (R5, R4, R3, R2, R1, R0, R0+R5, R1+R2+R3, R1+R2+R3+R5). Each half of the circuit is always set to the same value. Two of the programmable resistor boards are used in each unit.



## Digital Board Parts List

This section covers schematics DIG-1 through DIG-7.

Digital Board Assembly			
Ref No.	SRS Part No.	Value	Component Description
BT401	6-00001-612	BR-2/3A 2PIN PC	Battery
C 101	5-00017-501	47P	Capacitor, Ceramic Disc, 50V, 10%, SL
C 102	5-00017-501	47P	Capacitor, Ceramic Disc, 50V, 10%, SL
C 103	5-00017-501	47P	Capacitor, Ceramic Disc, 50V, 10%, SL
C 104	5-00063-513	.0033U	Capacitor, Mylar/Poly, 50V, 5%, Rad
C 204	5-00225-548	.1U AXIAL	Capacitor, Ceramic, 50V,+80/-20% Z5U AX
C 205	5-00064-513	.0047U	Capacitor, Mylar/Poly, 50V, 5%, Rad
C 206	5-00002-501	100P	Capacitor, Ceramic Disc, 50V, 10%, SL
C 207	5-00002-501	100P	Capacitor, Ceramic Disc, 50V, 10%, SL
C 208	5-00002-501	100P	Capacitor, Ceramic Disc, 50V, 10%, SL
C 209	5-00062-513	.0022U	Capacitor, Mylar/Poly, 50V, 5%, Rad
C 301	5-00061-513	.001U	Capacitor, Mylar/Poly, 50V, 5%, Rad
C 401	5-00225-548	.1U AXIAL	Capacitor, Ceramic, 50V,+80/-20% Z5U AX
C 402	5-00225-548	.1U AXIAL	Capacitor, Ceramic, 50V,+80/-20% Z5U AX
C 403	5-00100-517	2.2U	Capacitor, Tantalum, 35V, 20%, Rad
C 407	5-00040-509	1.0U	Capacitor, Electrolytic, 50V, 20%, Rad
C 408	5-00023-529	.1U	Cap, Monolythic Ceramic, 50V, 20%, Z5U
C 409	5-00034-526	100U	Capacitor, Electrolytic, 35V, 20%, Rad
C 501	5-00225-548	.1U AXIAL	Capacitor, Ceramic, 50V,+80/-20% Z5U AX
C 601	5-00023-529	.1U	Cap, Monolythic Ceramic, 50V, 20%, Z5U
C 602	5-00023-529	.1U	Cap, Monolythic Ceramic, 50V, 20%, Z5U
C 603	5-00023-529	.1U	Cap, Monolythic Ceramic, 50V, 20%, Z5U
C 604	5-00225-548	.1U AXIAL	Capacitor, Ceramic, 50V,+80/-20% Z5U AX
C 605	5-00023-529	.1U	Cap, Monolythic Ceramic, 50V, 20%, Z5U
C 701	5-00023-529	.1U	Cap, Monolythic Ceramic, 50V, 20%, Z5U
C 702	5-00258-520	15000U	Capacitor, Electrolytic, 16V, 20%, Rad
C 703	5-00192-542	22U MIN	Cap, Mini Electrolytic, 50V, 20% Radial
C 704	5-00100-517	2.2U	Capacitor, Tantalum, 35V, 20%, Rad
C 705	5-00100-517	2.2U	Capacitor, Tantalum, 35V, 20%, Rad
C 706	5-00225-548	.1U AXIAL	Capacitor, Ceramic, 50V,+80/-20% Z5U AX
C 707	5-00225-548	.1U AXIAL	Capacitor, Ceramic, 50V,+80/-20% Z5U AX
C 708	5-00225-548	.1U AXIAL	Capacitor, Ceramic, 50V,+80/-20% Z5U AX
C 709	5-00225-548	.1U AXIAL	Capacitor, Ceramic, 50V,+80/-20% Z5U AX
C 710	5-00225-548	.1U AXIAL	Capacitor, Ceramic, 50V,+80/-20% Z5U AX
C 711	5-00225-548	.1U AXIAL	Capacitor, Ceramic, 50V,+80/-20% Z5U AX
C 712	5-00225-548	.1U AXIAL	Capacitor, Ceramic, 50V,+80/-20% Z5U AX
C 713	5-00225-548	.1U AXIAL	Capacitor, Ceramic, 50V,+80/-20% Z5U AX
C 714	5-00225-548	.1U AXIAL	Capacitor, Ceramic, 50V,+80/-20% Z5U AX
C 715	5-00225-548	.1U AXIAL	Capacitor, Ceramic, 50V,+80/-20% Z5U AX
C 716	5-00225-548	.1U AXIAL	Capacitor, Ceramic, 50V,+80/-20% Z5U AX
C 717	5-00225-548	.1U AXIAL	Capacitor, Ceramic, 50V,+80/-20% Z5U AX
C 718	5-00225-548	.1U AXIAL	Capacitor, Ceramic, 50V,+80/-20% Z5U AX
C 719	5-00225-548	.1U AXIAL	Capacitor, Ceramic, 50V,+80/-20% Z5U AX
C 720	5-00225-548	.1U AXIAL	Capacitor, Ceramic, 50V,+80/-20% Z5U AX
C 721	5-00225-548	.1U AXIAL	Capacitor, Ceramic, 50V,+80/-20% Z5U AX

## 6-12 Parts List

C 722	5-00225-548	.1U AXIAL	Capacitor, Ceramic, 50V,+80/-20% Z5U AX
C 723	5-00225-548	.1U AXIAL	Capacitor, Ceramic, 50V,+80/-20% Z5U AX
C 724	5-00225-548	.1U AXIAL	Capacitor, Ceramic, 50V,+80/-20% Z5U AX
C 725	5-00225-548	.1U AXIAL	Capacitor, Ceramic, 50V,+80/-20% Z5U AX
C 726	5-00225-548	.1U AXIAL	Capacitor, Ceramic, 50V,+80/-20% Z5U AX
C 727	5-00225-548	.1U AXIAL	Capacitor, Ceramic, 50V,+80/-20% Z5U AX
C 728	5-00225-548	.1U AXIAL	Capacitor, Ceramic, 50V,+80/-20% Z5U AX
C 729	5-00225-548	.1U AXIAL	Capacitor, Ceramic, 50V,+80/-20% Z5U AX
C 730	5-00225-548	.1U AXIAL	Capacitor, Ceramic, 50V,+80/-20% Z5U AX
C 731	5-00225-548	.1U AXIAL	Capacitor, Ceramic, 50V,+80/-20% Z5U AX
C 732	5-00225-548	.1U AXIAL	Capacitor, Ceramic, 50V,+80/-20% Z5U AX
C 733	5-00225-548	.1U AXIAL	Capacitor, Ceramic, 50V,+80/-20% Z5U AX
C 734	5-00225-548	.1U AXIAL	Capacitor, Ceramic, 50V,+80/-20% Z5U AX
C 735	5-00225-548	.1U AXIAL	Capacitor, Ceramic, 50V,+80/-20% Z5U AX
C 736	5-00225-548	.1U AXIAL	Capacitor, Ceramic, 50V,+80/-20% Z5U AX
C 737	5-00225-548	.1U AXIAL	Capacitor, Ceramic, 50V,+80/-20% Z5U AX
C 738	5-00225-548	.1U AXIAL	Capacitor, Ceramic, 50V,+80/-20% Z5U AX
C 739	5-00225-548	.1U AXIAL	Capacitor, Ceramic, 50V,+80/-20% Z5U AX
C 740	5-00225-548	.1U AXIAL	Capacitor, Ceramic, 50V,+80/-20% Z5U AX
C 741	5-00225-548	.1U AXIAL	Capacitor, Ceramic, 50V,+80/-20% Z5U AX
C 742	5-00225-548	.1U AXIAL	Capacitor, Ceramic, 50V,+80/-20% Z5U AX
C 743	5-00225-548	.1U AXIAL	Capacitor, Ceramic, 50V,+80/-20% Z5U AX
C 744	5-00225-548	.1U AXIAL	Capacitor, Ceramic, 50V,+80/-20% Z5U AX
C 745	5-00225-548	.1U AXIAL	Capacitor, Ceramic, 50V,+80/-20% Z5U AX
C 746	5-00225-548	.1U AXIAL	Capacitor, Ceramic, 50V,+80/-20% Z5U AX
C 747	5-00225-548	.1U AXIAL	Capacitor, Ceramic, 50V,+80/-20% Z5U AX
C 748	5-00225-548	.1U AXIAL	Capacitor, Ceramic, 50V,+80/-20% Z5U AX
C 749	5-00225-548	.1U AXIAL	Capacitor, Ceramic, 50V,+80/-20% Z5U AX
C 750	5-00225-548	.1U AXIAL	Capacitor, Ceramic, 50V,+80/-20% Z5U AX
C 770	5-00225-548	.1U AXIAL	Capacitor, Ceramic, 50V,+80/-20% Z5U AX
C 771	5-00225-548	.1U AXIAL	Capacitor, Ceramic, 50V,+80/-20% Z5U AX
C 772	5-00225-548	.1U AXIAL	Capacitor, Ceramic, 50V,+80/-20% Z5U AX
C 773	5-00225-548	.1U AXIAL	Capacitor, Ceramic, 50V,+80/-20% Z5U AX
C 774	5-00225-548	.1U AXIAL	Capacitor, Ceramic, 50V,+80/-20% Z5U AX
D 401	3-00004-301	1N4148	Diode
D 402	3-00004-301	1N4148	Diode
D 403	3-00004-301	1N4148	Diode
D 701	3-00001-301	1N4001	Diode
D 702	3-00001-301	1N4001	Diode
J 201	0-00388-000	RCA PHONO	Hardware, Misc.
J 204	1-00233-120	RT ANGLE	Connector, BNC
J 205	1-00233-120	RT ANGLE	Connector, BNC
J 401	1-00086-130	3 PIN SI	Connector, Male
J 501	1-00171-130	34 PIN ELH	Connector, Male
J 601	1-00160-162	IEEE488/STAND.	Connector, IEEE488, Standard, R/A, Femal
J 602	1-00016-160	RS232 25 PIN D	Connector, D-Sub, Right Angle PC, Female
J 701	1-00260-116	4 PIN, WHITE	Header, Amp, MTA-156
JP401	1-00087-131	2 PIN JUMPER	Connector, Female
L 401	6-00114-603	1.0MH	Inductor, Axial
N 101	4-00878-421	82X3	Res. Network, SIP, 1/4W,2% (Isolated)
N 102	4-00878-421	82X3	Res. Network, SIP, 1/4W,2% (Isolated)
N 103	4-00334-425	10KX5	Resistor Network SIP 1/4W 2% (Common)



N 104	4-00334-425	10KX5	Resistor Network SIP 1/4W 2% (Common)
N 501	4-00420-420	390X8	Resistor Network, DIP, 1/4W,2%,8 Ind
N 502	4-00468-420	300X8	Resistor Network, DIP, 1/4W,2%,8 Ind
N 503	4-00338-425	2.0KX5	Resistor Network SIP 1/4W 2% (Common)
N 504	4-00673-421	12X5	Res. Network, SIP, 1/4W,2% (Isolated)
P 201	4-00915-440	200	Trim Pot, Single Turn, In-Line Leads
PC1	7-00474-701	DS360 DIG	Printed Circuit Board
Q 401	3-00140-325	2N2369A	Transistor, TO-92 Package
Q 403	3-00021-325	2N3904	Transistor, TO-92 Package
R 101	4-00141-407	100	Resistor, Metal Film, 1/8W, 1%, 50PPM
R 203	4-00021-401	1.0K	Resistor, Carbon Film, 1/4W, 5%
R 204	4-00034-401	10K	Resistor, Carbon Film, 1/4W, 5%
R 205	4-00021-401	1.0K	Resistor, Carbon Film, 1/4W, 5%
R 206	4-00053-401	200	Resistor, Carbon Film, 1/4W, 5%
R 207	4-00053-401	200	Resistor, Carbon Film, 1/4W, 5%
R 208	4-00053-401	200	Resistor, Carbon Film, 1/4W, 5%
R 301	4-00021-401	1.0K	Resistor, Carbon Film, 1/4W, 5%
R 401	4-00021-401	1.0K	Resistor, Carbon Film, 1/4W, 5%
R 402	4-00034-401	10K	Resistor, Carbon Film, 1/4W, 5%
R 403	4-00079-401	4.7K	Resistor, Carbon Film, 1/4W, 5%
R 406	4-00034-401	10K	Resistor, Carbon Film, 1/4W, 5%
R 407	4-00054-401	200K	Resistor, Carbon Film, 1/4W, 5%
R 408	4-00065-401	3.3K	Resistor, Carbon Film, 1/4W, 5%
R 409	4-00080-401	47	Resistor, Carbon Film, 1/4W, 5%
R 410	4-00079-401	4.7K	Resistor, Carbon Film, 1/4W, 5%
R 501	4-00032-401	100K	Resistor, Carbon Film, 1/4W, 5%
R 502	4-00314-401	12	Resistor, Carbon Film, 1/4W, 5%
R 503	4-00314-401	12	Resistor, Carbon Film, 1/4W, 5%
R 601	4-00021-401	1.0K	Resistor, Carbon Film, 1/4W, 5%
R 602	4-00034-401	10K	Resistor, Carbon Film, 1/4W, 5%
R 603	4-00034-401	10K	Resistor, Carbon Film, 1/4W, 5%
R 604	4-00034-401	10K	Resistor, Carbon Film, 1/4W, 5%
R 701	4-00141-407	100	Resistor, Metal Film, 1/8W, 1%, 50PPM
R 702	4-00580-407	475	Resistor, Metal Film, 1/8W, 1%, 50PPM
SO402	1-00026-150	28 PIN 600 MIL	Socket, THRU-HOLE
SP401	6-00096-600	MINI	Misc. Components
SW701	2-00023-218	DPDT	Switch, Panel Mount, Power, Rocker
U 101	3-00611-360	DSP56002FC-40	Integrated Circuit (Surface Mount Pkg)
U 102	3-01116-341	71256SA20TP	STATIC RAM, I.C.
U 103	3-01116-341	71256SA20TP	STATIC RAM, I.C.
U 104	3-01116-341	71256SA20TP	STATIC RAM, I.C.
U 105	3-00488-340	74HC597	Integrated Circuit (Thru-hole Pkg)
U 106	3-00488-340	74HC597	Integrated Circuit (Thru-hole Pkg)
U 107	3-00488-340	74HC597	Integrated Circuit (Thru-hole Pkg)
U 109	3-00405-343	16V8-15	GAL/PAL, I.C.
U 111	3-00703-343	DS360/U111	GAL/PAL, I.C.
U 112	3-00707-343	DS360/U112	GAL/PAL, I.C.
U 113	3-00045-340	74HC32	Integrated Circuit (Thru-hole Pkg)
U 114	3-00704-343	DS360/U114	GAL/PAL, I.C.
U 115	3-00049-340	74HC74	Integrated Circuit (Thru-hole Pkg)
U 116	3-00049-340	74HC74	Integrated Circuit (Thru-hole Pkg)
U 117	3-00036-340	74HC00	Integrated Circuit (Thru-hole Pkg)

## 6-14 Parts List

---

U 118	3-00049-340	74HC74	Integrated Circuit (Thru-hole Pkg)
U 119	3-00274-340	74AC74	Integrated Circuit (Thru-hole Pkg)
U 207	3-00155-340	74HC04	Integrated Circuit (Thru-hole Pkg)
U 208	3-00039-340	74HC14	Integrated Circuit (Thru-hole Pkg)
U 210	3-00165-340	74HC08	Integrated Circuit (Thru-hole Pkg)
U 301	3-00705-343	DS360/U301A	GAL/PAL, I.C.
U 302	3-00706-343	DS360/U302	GAL/PAL, I.C.
U 303	3-00492-340	UPD71054C-10	Integrated Circuit (Thru-hole Pkg)
U 304	3-00046-340	74HC374	Integrated Circuit (Thru-hole Pkg)
U 305	3-00049-340	74HC74	Integrated Circuit (Thru-hole Pkg)
U 306	3-00049-340	74HC74	Integrated Circuit (Thru-hole Pkg)
U 307	3-00199-340	74HC4538	Integrated Circuit (Thru-hole Pkg)
U 401	3-00298-340	Z84C0008PEC	Integrated Circuit (Thru-hole Pkg)
U 403	3-00299-341	32KX8-70L	STATIC RAM, I.C.
U 404	3-00044-340	74HC244	Integrated Circuit (Thru-hole Pkg)
U 405	3-00492-340	UPD71054C-10	Integrated Circuit (Thru-hole Pkg)
U 406	3-00046-340	74HC374	Integrated Circuit (Thru-hole Pkg)
U 407	3-00158-340	74HC154N	Integrated Circuit (Thru-hole Pkg)
U 408	6-00191-621	32.333 MHZ	Crystal Oscillator
U 409	3-00404-340	74HC107	Integrated Circuit (Thru-hole Pkg)
U 410	3-00049-340	74HC74	Integrated Circuit (Thru-hole Pkg)
U 411	3-00155-340	74HC04	Integrated Circuit (Thru-hole Pkg)
U 412	3-00039-340	74HC14	Integrated Circuit (Thru-hole Pkg)
U 413	3-00700-343	DS360/U413	GAL/PAL, I.C.
U 414	3-00155-340	74HC04	Integrated Circuit (Thru-hole Pkg)
U 415	3-00348-340	74HC20	Integrated Circuit (Thru-hole Pkg)
U 501	3-00046-340	74HC374	Integrated Circuit (Thru-hole Pkg)
U 502	3-00278-340	UDN2585A	Integrated Circuit (Thru-hole Pkg)
U 503	3-00046-340	74HC374	Integrated Circuit (Thru-hole Pkg)
U 504	3-00199-340	74HC4538	Integrated Circuit (Thru-hole Pkg)
U 505	3-00046-340	74HC374	Integrated Circuit (Thru-hole Pkg)
U 506	3-00064-340	CA3081	Integrated Circuit (Thru-hole Pkg)
U 507	3-00044-340	74HC244	Integrated Circuit (Thru-hole Pkg)
U 508	3-00049-340	74HC74	Integrated Circuit (Thru-hole Pkg)
U 509	3-00049-340	74HC74	Integrated Circuit (Thru-hole Pkg)
U 510	3-00039-340	74HC14	Integrated Circuit (Thru-hole Pkg)
U 601	3-00645-340	NAT9914BPD	Integrated Circuit (Thru-hole Pkg)
U 602	3-00078-340	DS75160A	Integrated Circuit (Thru-hole Pkg)
U 603	3-00079-340	DS75161A	Integrated Circuit (Thru-hole Pkg)
U 604	3-00493-340	UPD71051C	Integrated Circuit (Thru-hole Pkg)
U 605	3-00605-340	MAX202	Integrated Circuit (Thru-hole Pkg)
U 703	3-00096-340	LM317L	Integrated Circuit (Thru-hole Pkg)
UZ409	0-00772-000	1.5" WIRE	Hardware, Misc.
Z 0	0-00089-033	4"	Tie
Z 0	0-00165-003	TO-18	Insulators

## Analog Board Parts List

This section covers schematics ANA-1 through ANA-7.

Analog Board Assembly			
Ref No.	SRS Part No.	Value	Component Description
C 101	5-00225-548	.1U AXIAL	Capacitor, Ceramic, 50V,+80/-20% Z5U AX
C 102	5-00225-548	.1U AXIAL	Capacitor, Ceramic, 50V,+80/-20% Z5U AX
C 103	5-00225-548	.1U AXIAL	Capacitor, Ceramic, 50V,+80/-20% Z5U AX
C 104	5-00225-548	.1U AXIAL	Capacitor, Ceramic, 50V,+80/-20% Z5U AX
C 105	5-00225-548	.1U AXIAL	Capacitor, Ceramic, 50V,+80/-20% Z5U AX
C 106	5-00225-548	.1U AXIAL	Capacitor, Ceramic, 50V,+80/-20% Z5U AX
C 111	5-00225-548	.1U AXIAL	Capacitor, Ceramic, 50V,+80/-20% Z5U AX
C 112	5-00225-548	.1U AXIAL	Capacitor, Ceramic, 50V,+80/-20% Z5U AX
C 117	5-00040-509	1.0U	Capacitor, Electrolytic, 50V, 20%, Rad
C 201	5-00100-517	2.2U	Capacitor, Tantalum, 35V, 20%, Rad
C 202	5-00098-517	10U	Capacitor, Tantalum, 35V, 20%, Rad
C 203	5-00327-517	22U	Capacitor, Tantalum, 35V, 20%, Rad
C 204	5-00100-517	2.2U	Capacitor, Tantalum, 35V, 20%, Rad
C 205	5-00100-517	2.2U	Capacitor, Tantalum, 35V, 20%, Rad
C 206	5-00098-517	10U	Capacitor, Tantalum, 35V, 20%, Rad
C 207	5-00250-532	82P	Capacitor, Ceramic Disc, 50V, 10% NPO
C 208	5-00148-545	1000P - 50V	Capacitor, Monolythic Ceramic, COG, 1%
C 209	5-00326-525	.001U	Capacitor, Polystyrene, 50V, 5%, Ax
C 210	5-00326-525	.001U	Capacitor, Polystyrene, 50V, 5%, Ax
C 211	5-00326-525	.001U	Capacitor, Polystyrene, 50V, 5%, Ax
C 212	5-00326-525	.001U	Capacitor, Polystyrene, 50V, 5%, Ax
C 213	5-00326-525	.001U	Capacitor, Polystyrene, 50V, 5%, Ax
C 214	5-00326-525	.001U	Capacitor, Polystyrene, 50V, 5%, Ax
C 215	5-00326-525	.001U	Capacitor, Polystyrene, 50V, 5%, Ax
C 216	5-00023-529	.1U	Cap, Monolythic Ceramic, 50V, 20%, Z5U
C 217	5-00053-512	.033U	Cap, Stacked Metal Film 50V 5% -40/+85c
C 218	5-00052-512	.01U	Cap, Stacked Metal Film 50V 5% -40/+85c
C 219	5-00050-566	.0033U	Cap, Polyester Film 50V 5% -40/+85c Rad
C 220	5-00023-529	.1U	Cap, Monolythic Ceramic, 50V, 20%, Z5U
C 221	5-00002-501	100P	Capacitor, Ceramic Disc, 50V, 10%, SL
C 222	5-00002-501	100P	Capacitor, Ceramic Disc, 50V, 10%, SL
C 223	5-00225-548	.1U AXIAL	Capacitor, Ceramic, 50V,+80/-20% Z5U AX
C 224	5-00100-517	2.2U	Capacitor, Tantalum, 35V, 20%, Rad
C 225	5-00106-530	9.0-50P	Capacitor, Variable, Misc.
C 226	5-00100-517	2.2U	Capacitor, Tantalum, 35V, 20%, Rad
C 227	5-00100-517	2.2U	Capacitor, Tantalum, 35V, 20%, Rad
C 228	5-00023-529	.1U	Cap, Monolythic Ceramic, 50V, 20%, Z5U
C 229	5-00023-529	.1U	Cap, Monolythic Ceramic, 50V, 20%, Z5U
C 230	5-00100-517	2.2U	Capacitor, Tantalum, 35V, 20%, Rad
C 231	5-00100-517	2.2U	Capacitor, Tantalum, 35V, 20%, Rad
C 232	5-00225-548	.1U AXIAL	Capacitor, Ceramic, 50V,+80/-20% Z5U AX
C 233	5-00225-548	.1U AXIAL	Capacitor, Ceramic, 50V,+80/-20% Z5U AX
C 234	5-00225-548	.1U AXIAL	Capacitor, Ceramic, 50V,+80/-20% Z5U AX
C 235	5-00225-548	.1U AXIAL	Capacitor, Ceramic, 50V,+80/-20% Z5U AX
C 236	5-00225-548	.1U AXIAL	Capacitor, Ceramic, 50V,+80/-20% Z5U AX

## 6-16 Parts List

C 237	5-00225-548	.1U AXIAL	Capacitor, Ceramic, 50V,+80/-20% Z5U AX
C 238	5-00225-548	.1U AXIAL	Capacitor, Ceramic, 50V,+80/-20% Z5U AX
C 239	5-00225-548	.1U AXIAL	Capacitor, Ceramic, 50V,+80/-20% Z5U AX
C 240	5-00225-548	.1U AXIAL	Capacitor, Ceramic, 50V,+80/-20% Z5U AX
C 241	5-00225-548	.1U AXIAL	Capacitor, Ceramic, 50V,+80/-20% Z5U AX
C 242	5-00225-548	.1U AXIAL	Capacitor, Ceramic, 50V,+80/-20% Z5U AX
C 243	5-00225-548	.1U AXIAL	Capacitor, Ceramic, 50V,+80/-20% Z5U AX
C 244	5-00225-548	.1U AXIAL	Capacitor, Ceramic, 50V,+80/-20% Z5U AX
C 245	5-00225-548	.1U AXIAL	Capacitor, Ceramic, 50V,+80/-20% Z5U AX
C 246	5-00148-545	1000P - 50V	Capacitor, Monolythic Ceramic, COG, 1%
C 247	5-00003-501	10P	Capacitor, Ceramic Disc, 50V, 10%, SL
C 301	5-00537-554	2.2U	Capacitor, Polypropylene, Radial
C 302	5-00323-554	.22U	Capacitor, Polypropylene, Radial
C 303	5-00324-554	.022U	Capacitor, Polypropylene, Radial
C 304	5-00325-525	.0022U	Capacitor, Polystyrene, 50V, 5%, Ax
C 305	5-00537-554	2.2U	Capacitor, Polypropylene, Radial
C 306	5-00323-554	.22U	Capacitor, Polypropylene, Radial
C 307	5-00324-554	.022U	Capacitor, Polypropylene, Radial
C 308	5-00325-525	.0022U	Capacitor, Polystyrene, 50V, 5%, Ax
C 309	5-00023-529	.1U	Cap, Monolythic Ceramic, 50V, 20%, Z5U
C 310	5-00225-548	.1U AXIAL	Capacitor, Ceramic, 50V,+80/-20% Z5U AX
C 311	5-00225-548	.1U AXIAL	Capacitor, Ceramic, 50V,+80/-20% Z5U AX
C 312	5-00225-548	.1U AXIAL	Capacitor, Ceramic, 50V,+80/-20% Z5U AX
C 313	5-00225-548	.1U AXIAL	Capacitor, Ceramic, 50V,+80/-20% Z5U AX
C 314	5-00225-548	.1U AXIAL	Capacitor, Ceramic, 50V,+80/-20% Z5U AX
C 315	5-00100-517	2.2U	Capacitor, Tantalum, 35V, 20%, Rad
C 316	5-00100-517	2.2U	Capacitor, Tantalum, 35V, 20%, Rad
C 317	5-00537-554	2.2U	Capacitor, Polypropylene, Radial
C 318	5-00323-554	.22U	Capacitor, Polypropylene, Radial
C 319	5-00324-554	.022U	Capacitor, Polypropylene, Radial
C 320	5-00325-525	.0022U	Capacitor, Polystyrene, 50V, 5%, Ax
C 321	5-00537-554	2.2U	Capacitor, Polypropylene, Radial
C 322	5-00323-554	.22U	Capacitor, Polypropylene, Radial
C 323	5-00324-554	.022U	Capacitor, Polypropylene, Radial
C 324	5-00325-525	.0022U	Capacitor, Polystyrene, 50V, 5%, Ax
C 325	5-00238-523	4P	Capacitor, Silver Mica, Miniature
C 326	5-00337-532	10P	Capacitor, Ceramic Disc, 50V, 10% NPO
C 327	5-00023-529	.1U	Cap, Monolythic Ceramic, 50V, 20%, Z5U
C 328	5-00225-548	.1U AXIAL	Capacitor, Ceramic, 50V,+80/-20% Z5U AX
C 329	5-00225-548	.1U AXIAL	Capacitor, Ceramic, 50V,+80/-20% Z5U AX
C 330	5-00225-548	.1U AXIAL	Capacitor, Ceramic, 50V,+80/-20% Z5U AX
C 331	5-00225-548	.1U AXIAL	Capacitor, Ceramic, 50V,+80/-20% Z5U AX
C 332	5-00225-548	.1U AXIAL	Capacitor, Ceramic, 50V,+80/-20% Z5U AX
C 333	5-00337-532	10P	Capacitor, Ceramic Disc, 50V, 10% NPO
C 334	5-00337-532	10P	Capacitor, Ceramic Disc, 50V, 10% NPO
C 335	5-00337-532	10P	Capacitor, Ceramic Disc, 50V, 10% NPO
C 336	5-00337-532	10P	Capacitor, Ceramic Disc, 50V, 10% NPO
C 337	5-00337-532	10P	Capacitor, Ceramic Disc, 50V, 10% NPO
C 338	5-00337-532	10P	Capacitor, Ceramic Disc, 50V, 10% NPO
C 339	5-00238-523	4P	Capacitor, Silver Mica, Miniature
C 401	5-00215-532	20P	Capacitor, Ceramic Disc, 50V, 10% NPO
C 402	5-00215-532	20P	Capacitor, Ceramic Disc, 50V, 10% NPO

C 403	5-00012-501	330P	Capacitor, Ceramic Disc, 50V, 10%, SL
C 404	5-00034-526	100U	Capacitor, Electrolytic, 35V, 20%, Rad
C 405	5-00100-517	2.2U	Capacitor, Tantalum, 35V, 20%, Rad
C 406	5-00100-517	2.2U	Capacitor, Tantalum, 35V, 20%, Rad
C 407	5-00023-529	.1U	Cap, Monolythic Ceramic, 50V, 20%, Z5U
C 408	5-00023-529	.1U	Cap, Monolythic Ceramic, 50V, 20%, Z5U
C 409	5-00023-529	.1U	Cap, Monolythic Ceramic, 50V, 20%, Z5U
C 410	5-00023-529	.1U	Cap, Monolythic Ceramic, 50V, 20%, Z5U
C 411	5-00002-501	100P	Capacitor, Ceramic Disc, 50V, 10%, SL
C 412	5-00002-501	100P	Capacitor, Ceramic Disc, 50V, 10%, SL
C 413	5-00148-545	1000P - 50V	Capacitor, Monolythic Ceramic, COG, 1%
C 414	5-00100-517	2.2U	Capacitor, Tantalum, 35V, 20%, Rad
C 415	5-00100-517	2.2U	Capacitor, Tantalum, 35V, 20%, Rad
C 416	5-00225-548	.1U AXIAL	Capacitor, Ceramic, 50V,+80/-20% Z5U AX
C 417	5-00023-529	.1U	Cap, Monolythic Ceramic, 50V, 20%, Z5U
C 418	5-00337-532	10P	Capacitor, Ceramic Disc, 50V, 10% NPO
C 501	5-00337-532	10P	Capacitor, Ceramic Disc, 50V, 10% NPO
C 502	5-00053-512	.033U	Cap, Stacked Metal Film 50V 5% -40/+85c
C 503	5-00536-516	30P	Capacitor, Silver Mica, 500V, 5%,
C 504	5-00225-548	.1U AXIAL	Capacitor, Ceramic, 50V,+80/-20% Z5U AX
C 505	5-00270-532	51P	Capacitor, Ceramic Disc, 50V, 10% NPO
C 506	5-00225-548	.1U AXIAL	Capacitor, Ceramic, 50V,+80/-20% Z5U AX
C 507	5-00028-507	100P	Capacitor, Ceramic Disc,250V, 10%, Y5P
C 508	5-00028-507	100P	Capacitor, Ceramic Disc,250V, 10%, Y5P
C 509	5-00225-548	.1U AXIAL	Capacitor, Ceramic, 50V,+80/-20% Z5U AX
C 510	5-00041-509	220U	Capacitor, Electrolytic, 50V, 20%, Rad
C 511	5-00041-509	220U	Capacitor, Electrolytic, 50V, 20%, Rad
C 512	5-00337-532	10P	Capacitor, Ceramic Disc, 50V, 10% NPO
C 513	5-00053-512	.033U	Cap, Stacked Metal Film 50V 5% -40/+85c
C 514	5-00536-516	30P	Capacitor, Silver Mica, 500V, 5%,
C 515	5-00225-548	.1U AXIAL	Capacitor, Ceramic, 50V,+80/-20% Z5U AX
C 516	5-00270-532	51P	Capacitor, Ceramic Disc, 50V, 10% NPO
C 517	5-00225-548	.1U AXIAL	Capacitor, Ceramic, 50V,+80/-20% Z5U AX
C 520	5-00225-548	.1U AXIAL	Capacitor, Ceramic, 50V,+80/-20% Z5U AX
C 521	5-00041-509	220U	Capacitor, Electrolytic, 50V, 20%, Rad
C 522	5-00041-509	220U	Capacitor, Electrolytic, 50V, 20%, Rad
C 523	5-00023-529	.1U	Cap, Monolythic Ceramic, 50V, 20%, Z5U
C 524	5-00023-529	.1U	Cap, Monolythic Ceramic, 50V, 20%, Z5U
C 525	5-00100-517	2.2U	Capacitor, Tantalum, 35V, 20%, Rad
C 526	5-00100-517	2.2U	Capacitor, Tantalum, 35V, 20%, Rad
C 527	5-00023-529	.1U	Cap, Monolythic Ceramic, 50V, 20%, Z5U
C 528	5-00023-529	.1U	Cap, Monolythic Ceramic, 50V, 20%, Z5U
C 529	5-00100-517	2.2U	Capacitor, Tantalum, 35V, 20%, Rad
C 530	5-00100-517	2.2U	Capacitor, Tantalum, 35V, 20%, Rad
C 531	5-00225-548	.1U AXIAL	Capacitor, Ceramic, 50V,+80/-20% Z5U AX
C 532	5-00023-529	.1U	Cap, Monolythic Ceramic, 50V, 20%, Z5U
C 533	5-00225-548	.1U AXIAL	Capacitor, Ceramic, 50V,+80/-20% Z5U AX
C 534	5-00225-548	.1U AXIAL	Capacitor, Ceramic, 50V,+80/-20% Z5U AX
C 535	5-00238-523	4P	Capacitor, Silver Mica, Miniature
C 536	5-00238-523	4P	Capacitor, Silver Mica, Miniature
C 701	5-00225-548	.1U AXIAL	Capacitor, Ceramic, 50V,+80/-20% Z5U AX
C 702	5-00225-548	.1U AXIAL	Capacitor, Ceramic, 50V,+80/-20% Z5U AX

## 6-18 Parts List

---

C 703	5-00321-509	2200U	Capacitor, Electrolytic, 50V, 20%, Rad
C 704	5-00192-542	22U MIN	Cap, Mini Electrolytic, 50V, 20% Radial
C 705	5-00321-509	2200U	Capacitor, Electrolytic, 50V, 20%, Rad
C 706	5-00192-542	22U MIN	Cap, Mini Electrolytic, 50V, 20% Radial
C 707	5-00192-542	22U MIN	Cap, Mini Electrolytic, 50V, 20% Radial
C 708	5-00192-542	22U MIN	Cap, Mini Electrolytic, 50V, 20% Radial
C 709	5-00041-509	220U	Capacitor, Electrolytic, 50V, 20%, Rad
C 710	5-00041-509	220U	Capacitor, Electrolytic, 50V, 20%, Rad
C 711	5-00219-529	.01U	Cap, Monolythic Ceramic, 50V, 20%, Z5U
C 712	5-00022-501	.001U	Capacitor, Ceramic Disc, 50V, 10%, SL
C 713	5-00219-529	.01U	Cap, Monolythic Ceramic, 50V, 20%, Z5U
C 714	5-00022-501	.001U	Capacitor, Ceramic Disc, 50V, 10%, SL
C 715	5-00219-529	.01U	Cap, Monolythic Ceramic, 50V, 20%, Z5U
C 716	5-00022-501	.001U	Capacitor, Ceramic Disc, 50V, 10%, SL
C 717	5-00219-529	.01U	Cap, Monolythic Ceramic, 50V, 20%, Z5U
C 718	5-00022-501	.001U	Capacitor, Ceramic Disc, 50V, 10%, SL
C 719	5-00320-526	4700U	Capacitor, Electrolytic, 35V, 20%, Rad
C 720	5-00192-542	22U MIN	Cap, Mini Electrolytic, 50V, 20% Radial
C 721	5-00320-526	4700U	Capacitor, Electrolytic, 35V, 20%, Rad
C 722	5-00192-542	22U MIN	Cap, Mini Electrolytic, 50V, 20% Radial
C 723	5-00281-521	220U	Capacitor, Electrolytic, 25V, 20%, Rad
C 724	5-00281-521	220U	Capacitor, Electrolytic, 25V, 20%, Rad
C 725	5-00219-529	.01U	Cap, Monolythic Ceramic, 50V, 20%, Z5U
C 726	5-00022-501	.001U	Capacitor, Ceramic Disc, 50V, 10%, SL
C 727	5-00219-529	.01U	Cap, Monolythic Ceramic, 50V, 20%, Z5U
C 728	5-00022-501	.001U	Capacitor, Ceramic Disc, 50V, 10%, SL
C 729	5-00219-529	.01U	Cap, Monolythic Ceramic, 50V, 20%, Z5U
C 730	5-00022-501	.001U	Capacitor, Ceramic Disc, 50V, 10%, SL
C 731	5-00219-529	.01U	Cap, Monolythic Ceramic, 50V, 20%, Z5U
C 732	5-00022-501	.001U	Capacitor, Ceramic Disc, 50V, 10%, SL
C 733	5-00100-517	2.2U	Capacitor, Tantalum, 35V, 20%, Rad
C 734	5-00100-517	2.2U	Capacitor, Tantalum, 35V, 20%, Rad
C 735	5-00227-526	100U	Capacitor, Electrolytic, 35V, 20%, Rad
C 736	5-00100-517	2.2U	Capacitor, Tantalum, 35V, 20%, Rad
C 737	5-00100-517	2.2U	Capacitor, Tantalum, 35V, 20%, Rad
C 738	5-00100-517	2.2U	Capacitor, Tantalum, 35V, 20%, Rad
C 739	5-00100-517	2.2U	Capacitor, Tantalum, 35V, 20%, Rad
C 740	5-00227-526	100U	Capacitor, Electrolytic, 35V, 20%, Rad
C 741	5-00225-548	.1U AXIAL	Capacitor, Ceramic, 50V,+80/-20% Z5U AX
C 742	5-00225-548	.1U AXIAL	Capacitor, Ceramic, 50V,+80/-20% Z5U AX
C 743	5-00225-548	.1U AXIAL	Capacitor, Ceramic, 50V,+80/-20% Z5U AX
C 744	5-00225-548	.1U AXIAL	Capacitor, Ceramic, 50V,+80/-20% Z5U AX
C 745	5-00225-548	.1U AXIAL	Capacitor, Ceramic, 50V,+80/-20% Z5U AX
C 746	5-00225-548	.1U AXIAL	Capacitor, Ceramic, 50V,+80/-20% Z5U AX
C 747	5-00225-548	.1U AXIAL	Capacitor, Ceramic, 50V,+80/-20% Z5U AX
C 748	5-00225-548	.1U AXIAL	Capacitor, Ceramic, 50V,+80/-20% Z5U AX
C 749	5-00225-548	.1U AXIAL	Capacitor, Ceramic, 50V,+80/-20% Z5U AX
C 755	5-00225-548	.1U AXIAL	Capacitor, Ceramic, 50V,+80/-20% Z5U AX
C 756	5-00225-548	.1U AXIAL	Capacitor, Ceramic, 50V,+80/-20% Z5U AX
C 757	5-00023-529	.1U	Cap, Monolythic Ceramic, 50V, 20%, Z5U
C 758	5-00225-548	.1U AXIAL	Capacitor, Ceramic, 50V,+80/-20% Z5U AX
C 759	5-00023-529	.1U	Cap, Monolythic Ceramic, 50V, 20%, Z5U

C 760	5-00100-517	2.2U	Capacitor, Tantalum, 35V, 20%, Rad
C 761	5-00100-517	2.2U	Capacitor, Tantalum, 35V, 20%, Rad
C 762	5-00100-517	2.2U	Capacitor, Tantalum, 35V, 20%, Rad
C 763	5-00100-517	2.2U	Capacitor, Tantalum, 35V, 20%, Rad
C 770	5-00023-529	.1U	Cap, Monolythic Ceramic, 50V, 20%, Z5U
C 771	5-00023-529	.1U	Cap, Monolythic Ceramic, 50V, 20%, Z5U
C 772	5-00023-529	.1U	Cap, Monolythic Ceramic, 50V, 20%, Z5U
C 773	5-00225-548	.1U AXIAL	Capacitor, Ceramic, 50V,+80/-20% Z5U AX
C 774	5-00023-529	.1U	Cap, Monolythic Ceramic, 50V, 20%, Z5U
C 775	5-00023-529	.1U	Cap, Monolythic Ceramic, 50V, 20%, Z5U
C 776	5-00281-521	220U	Capacitor, Electrolytic, 25V, 20%, Rad
C 777	5-00281-521	220U	Capacitor, Electrolytic, 25V, 20%, Rad
C 780	5-00023-529	.1U	Cap, Monolythic Ceramic, 50V, 20%, Z5U
C 781	5-00023-529	.1U	Cap, Monolythic Ceramic, 50V, 20%, Z5U
C 782	5-00023-529	.1U	Cap, Monolythic Ceramic, 50V, 20%, Z5U
C 783	5-00023-529	.1U	Cap, Monolythic Ceramic, 50V, 20%, Z5U
C 784	5-00023-529	.1U	Cap, Monolythic Ceramic, 50V, 20%, Z5U
C 785	5-00023-529	.1U	Cap, Monolythic Ceramic, 50V, 20%, Z5U
C 786	5-00281-521	220U	Capacitor, Electrolytic, 25V, 20%, Rad
C 787	5-00281-521	220U	Capacitor, Electrolytic, 25V, 20%, Rad
C 790	5-00225-548	.1U AXIAL	Capacitor, Ceramic, 50V,+80/-20% Z5U AX
C 791	5-00225-548	.1U AXIAL	Capacitor, Ceramic, 50V,+80/-20% Z5U AX
C 792	5-00225-548	.1U AXIAL	Capacitor, Ceramic, 50V,+80/-20% Z5U AX
C 793	5-00225-548	.1U AXIAL	Capacitor, Ceramic, 50V,+80/-20% Z5U AX
C 794	5-00225-548	.1U AXIAL	Capacitor, Ceramic, 50V,+80/-20% Z5U AX
C 795	5-00225-548	.1U AXIAL	Capacitor, Ceramic, 50V,+80/-20% Z5U AX
C 796	5-00225-548	.1U AXIAL	Capacitor, Ceramic, 50V,+80/-20% Z5U AX
D 501	3-00004-301	1N4148	Diode
D 502	3-00638-301	1N5234A	Diode
D 503	3-00004-301	1N4148	Diode
D 504	3-00004-301	1N4148	Diode
D 505	3-00004-301	1N4148	Diode
D 506	3-00004-301	1N4148	Diode
D 507	3-00638-301	1N5234A	Diode
D 508	3-00004-301	1N4148	Diode
D 509	3-00004-301	1N4148	Diode
D 510	3-00004-301	1N4148	Diode
D 701	3-00062-340	KBP201G/BR-81D	Integrated Circuit (Thru-hole Pkg)
D 702	3-00062-340	KBP201G/BR-81D	Integrated Circuit (Thru-hole Pkg)
J 601	0-00051-056	RG174	Cable, Coax & Misc.
J 602	0-00051-056	RG174	Cable, Coax & Misc.
J 701	1-00039-116	5 PIN, WHITE	Header, Amp, MTA-156
K 201	3-00617-335	DS1E-ML2-DC5V	Relay
K 202	3-00617-335	DS1E-ML2-DC5V	Relay
K 301	3-00523-335	G6AK-234P-ST-UC	Relay
K 302	3-00523-335	G6AK-234P-ST-UC	Relay
K 303	3-00617-335	DS1E-ML2-DC5V	Relay
K 304	3-00523-335	G6AK-234P-ST-UC	Relay
K 305	3-00523-335	G6AK-234P-ST-UC	Relay
K 401	3-00523-335	G6AK-234P-ST-UC	Relay
K 402	3-00523-335	G6AK-234P-ST-UC	Relay
K 403	3-00523-335	G6AK-234P-ST-UC	Relay

## 6-20 Parts List

K 404	3-00523-335	G6AK-234P-ST-UC	Relay
K 405	3-00617-335	DS1E-ML2-DC5V	Relay
K 406	3-00523-335	G6AK-234P-ST-UC	Relay
K 407	3-00617-335	DS1E-ML2-DC5V	Relay
K 601	3-00523-335	G6AK-234P-ST-UC	Relay
K 602	3-00523-335	G6AK-234P-ST-UC	Relay
K 603	3-00523-335	G6AK-234P-ST-UC	Relay
K 604	3-00523-335	G6AK-234P-ST-UC	Relay
K 605	3-00523-335	G6AK-234P-ST-UC	Relay
K 606	3-00523-335	G6AK-234P-ST-UC	Relay
K 607	3-00523-335	G6AK-234P-ST-UC	Relay
L 401	6-00114-603	1.0MH	Inductor, Axial
L 701	6-00055-630	FB43-1801	Ferrite Beads
L 702	6-00055-630	FB43-1801	Ferrite Beads
L 703	6-00055-630	FB43-1801	Ferrite Beads
L 704	6-00055-630	FB43-1801	Ferrite Beads
L 705	6-00055-630	FB43-1801	Ferrite Beads
L 706	6-00055-630	FB43-1801	Ferrite Beads
L 707	6-00055-630	FB43-1801	Ferrite Beads
L 708	6-00055-630	FB43-1801	Ferrite Beads
N 101	4-00880-425	390X5	Resistor Network SIP 1/4W 2% (Common)
N 102	4-00298-425	470X5	Resistor Network SIP 1/4W 2% (Common)
N 201	4-00690-421	3.3KX4	Res. Network, SIP, 1/4W,2% (Isolated)
N 202	4-00693-421	270X5	Res. Network, SIP, 1/4W,2% (Isolated)
N 203	4-00881-425	22X5	Resistor Network SIP 1/4W 2% (Common)
N 204	4-00881-425	22X5	Resistor Network SIP 1/4W 2% (Common)
N 205	4-00881-425	22X5	Resistor Network SIP 1/4W 2% (Common)
N 206	4-00881-425	22X5	Resistor Network SIP 1/4W 2% (Common)
N 207	4-00881-425	22X5	Resistor Network SIP 1/4W 2% (Common)
N 208	4-00881-425	22X5	Resistor Network SIP 1/4W 2% (Common)
N 301	4-00877-425	22X7	Resistor Network SIP 1/4W 2% (Common)
N 302	4-00877-425	22X7	Resistor Network SIP 1/4W 2% (Common)
N 401	4-00881-425	22X5	Resistor Network SIP 1/4W 2% (Common)
N 402	4-00881-425	22X5	Resistor Network SIP 1/4W 2% (Common)
P 201	4-00901-441	500K	Pot, Multi-Turn Trim, 3/8" Square Top Ad
P 202	4-00617-441	100K	Pot, Multi-Turn Trim, 3/8" Square Top Ad
P 203	4-00617-441	100K	Pot, Multi-Turn Trim, 3/8" Square Top Ad
P 301	4-00617-441	100K	Pot, Multi-Turn Trim, 3/8" Square Top Ad
P 401	4-00617-441	100K	Pot, Multi-Turn Trim, 3/8" Square Top Ad
P 501	4-00485-441	1K	Pot, Multi-Turn Trim, 3/8" Square Top Ad
P 502	4-00370-441	500	Pot, Multi-Turn Trim, 3/8" Square Top Ad
P 503	4-00485-441	1K	Pot, Multi-Turn Trim, 3/8" Square Top Ad
P 504	4-00485-441	1K	Pot, Multi-Turn Trim, 3/8" Square Top Ad
P 505	4-00370-441	500	Pot, Multi-Turn Trim, 3/8" Square Top Ad
P 506	4-00353-441	100	Pot, Multi-Turn Trim, 3/8" Square Top Ad
PC1	7-00412-701	DS360 ANALOG	Printed Circuit Board
Q 501	3-00022-325	2N3906	Transistor, TO-92 Package
Q 502	3-00022-325	2N3906	Transistor, TO-92 Package
Q 503	3-00021-325	2N3904	Transistor, TO-92 Package
Q 504	3-00021-325	2N3904	Transistor, TO-92 Package
Q 505	3-00021-325	2N3904	Transistor, TO-92 Package
Q 506	3-00022-325	2N3906	Transistor, TO-92 Package



Q 507	3-00022-325	2N3906	Transistor, TO-92 Package
Q 508	3-00620-321	2N3251	Transistor, TO-18 Package
Q 509	3-00021-325	2N3904	Transistor, TO-92 Package
Q 510	3-00021-325	2N3904	Transistor, TO-92 Package
Q 511	3-00021-325	2N3904	Transistor, TO-92 Package
Q 512	3-00621-322	2N3019	Transistor, TO-39 Package
Q 513	3-00622-322	2N4405	Transistor, TO-39 Package
Q 514	3-00022-325	2N3906	Transistor, TO-92 Package
Q 515	3-00022-325	2N3906	Transistor, TO-92 Package
Q 516	3-00021-325	2N3904	Transistor, TO-92 Package
Q 517	3-00021-325	2N3904	Transistor, TO-92 Package
Q 518	3-00021-325	2N3904	Transistor, TO-92 Package
Q 519	3-00022-325	2N3906	Transistor, TO-92 Package
Q 520	3-00022-325	2N3906	Transistor, TO-92 Package
Q 521	3-00620-321	2N3251	Transistor, TO-18 Package
Q 522	3-00021-325	2N3904	Transistor, TO-92 Package
Q 523	3-00021-325	2N3904	Transistor, TO-92 Package
Q 524	3-00621-322	2N3019	Transistor, TO-39 Package
Q 525	3-00622-322	2N4405	Transistor, TO-39 Package
Q 526	3-00021-325	2N3904	Transistor, TO-92 Package
Q 601	3-00021-325	2N3904	Transistor, TO-92 Package
Q 602	3-00021-325	2N3904	Transistor, TO-92 Package
Q 603	3-00021-325	2N3904	Transistor, TO-92 Package
R 101	4-00088-401	51K	Resistor, Carbon Film, 1/4W, 5%
R 102	4-00471-401	82	Resistor, Carbon Film, 1/4W, 5%
R 103	4-00080-401	47	Resistor, Carbon Film, 1/4W, 5%
R 104	4-00080-401	47	Resistor, Carbon Film, 1/4W, 5%
R 105	4-00080-401	47	Resistor, Carbon Film, 1/4W, 5%
R 201	4-00056-401	22	Resistor, Carbon Film, 1/4W, 5%
R 202	4-00056-401	22	Resistor, Carbon Film, 1/4W, 5%
R 203	4-00056-401	22	Resistor, Carbon Film, 1/4W, 5%
R 204	4-00056-401	22	Resistor, Carbon Film, 1/4W, 5%
R 205	4-00141-407	100	Resistor, Metal Film, 1/8W, 1%, 50PPM
R 206	4-00582-407	2.15K	Resistor, Metal Film, 1/8W, 1%, 50PPM
R 207	4-00575-407	22.1	Resistor, Metal Film, 1/8W, 1%, 50PPM
R 208	4-00768-407	1.27K	Resistor, Metal Film, 1/8W, 1%, 50PPM
R 209	4-00409-408	1.210K	Resistor, Metal Film, 1/8W, 0.1%, 25ppm
R 210	4-00409-408	1.210K	Resistor, Metal Film, 1/8W, 0.1%, 25ppm
R 211	4-00884-407	1.18K	Resistor, Metal Film, 1/8W, 1%, 50PPM
R 212	4-00661-407	130	Resistor, Metal Film, 1/8W, 1%, 50PPM
R 213	4-00308-407	1.02K	Resistor, Metal Film, 1/8W, 1%, 50PPM
R 214	4-00409-408	1.210K	Resistor, Metal Film, 1/8W, 0.1%, 25ppm
R 215	4-00409-408	1.210K	Resistor, Metal Film, 1/8W, 0.1%, 25ppm
R 216	4-00209-407	887	Resistor, Metal Film, 1/8W, 1%, 50PPM
R 217	4-00737-407	162	Resistor, Metal Film, 1/8W, 1%, 50PPM
R 218	4-00743-407	536	Resistor, Metal Film, 1/8W, 1%, 50PPM
R 219	4-00409-408	1.210K	Resistor, Metal Film, 1/8W, 0.1%, 25ppm
R 220	4-00409-408	1.210K	Resistor, Metal Film, 1/8W, 0.1%, 25ppm
R 221	4-00661-407	130	Resistor, Metal Film, 1/8W, 1%, 50PPM
R 222	4-00479-407	66.5K	Resistor, Metal Film, 1/8W, 1%, 50PPM
R 223	4-00457-407	33.2K	Resistor, Metal Film, 1/8W, 1%, 50PPM
R 224	4-00138-407	10.0K	Resistor, Metal Film, 1/8W, 1%, 50PPM

## 6-22 Parts List

---

R 225	4-00161-407	2.49K	Resistor, Metal Film, 1/8W, 1%, 50PPM
R 226	4-00130-407	1.00K	Resistor, Metal Film, 1/8W, 1%, 50PPM
R 227	4-00885-407	3.32M	Resistor, Metal Film, 1/8W, 1%, 50PPM
R 228	4-00210-407	9.09K	Resistor, Metal Film, 1/8W, 1%, 50PPM
R 229	4-00526-407	232	Resistor, Metal Film, 1/8W, 1%, 50PPM
R 230	4-00193-407	499	Resistor, Metal Film, 1/8W, 1%, 50PPM
R 231	4-00131-407	1.00M	Resistor, Metal Film, 1/8W, 1%, 50PPM
R 232	4-00138-407	10.0K	Resistor, Metal Film, 1/8W, 1%, 50PPM
R 233	4-00517-407	3.57K	Resistor, Metal Film, 1/8W, 1%, 50PPM
R 235	4-00391-407	78.7K	Resistor, Metal Film, 1/8W, 1%, 50PPM
R 237	4-00138-407	10.0K	Resistor, Metal Film, 1/8W, 1%, 50PPM
R 239	4-00137-407	1.91K	Resistor, Metal Film, 1/8W, 1%, 50PPM
R 240	4-00188-407	4.99K	Resistor, Metal Film, 1/8W, 1%, 50PPM
R 241	4-00150-407	13.0K	Resistor, Metal Film, 1/8W, 1%, 50PPM
R 242	4-00418-407	7.32K	Resistor, Metal Film, 1/8W, 1%, 50PPM
R 243	4-00582-407	2.15K	Resistor, Metal Film, 1/8W, 1%, 50PPM
R 244	4-00193-407	499	Resistor, Metal Film, 1/8W, 1%, 50PPM
R 245	4-00193-407	499	Resistor, Metal Film, 1/8W, 1%, 50PPM
R 246	4-00193-407	499	Resistor, Metal Film, 1/8W, 1%, 50PPM
R 247	4-00715-407	22.1K	Resistor, Metal Film, 1/8W, 1%, 50PPM
R 248	4-00142-407	100K	Resistor, Metal Film, 1/8W, 1%, 50PPM
R 301	4-00330-407	1.65K	Resistor, Metal Film, 1/8W, 1%, 50PPM
R 302	4-00158-407	2.00K	Resistor, Metal Film, 1/8W, 1%, 50PPM
R 303	4-00158-407	2.00K	Resistor, Metal Film, 1/8W, 1%, 50PPM
R 304	4-00130-407	1.00K	Resistor, Metal Film, 1/8W, 1%, 50PPM
R 305	4-00158-407	2.00K	Resistor, Metal Film, 1/8W, 1%, 50PPM
R 306	4-00158-407	2.00K	Resistor, Metal Film, 1/8W, 1%, 50PPM
R 307	4-00158-407	2.00K	Resistor, Metal Film, 1/8W, 1%, 50PPM
R 308	4-00158-407	2.00K	Resistor, Metal Film, 1/8W, 1%, 50PPM
R 309	4-00130-407	1.00K	Resistor, Metal Film, 1/8W, 1%, 50PPM
R 310	4-00699-407	1.54K	Resistor, Metal Film, 1/8W, 1%, 50PPM
R 313	4-00130-407	1.00K	Resistor, Metal Film, 1/8W, 1%, 50PPM
R 314	4-00779-407	133	Resistor, Metal Film, 1/8W, 1%, 50PPM
R 315	4-00193-407	499	Resistor, Metal Film, 1/8W, 1%, 50PPM
R 316	4-00715-407	22.1K	Resistor, Metal Film, 1/8W, 1%, 50PPM
R 401	4-00141-407	100	Resistor, Metal Film, 1/8W, 1%, 50PPM
R 402	4-00193-407	499	Resistor, Metal Film, 1/8W, 1%, 50PPM
R 403	4-00141-407	100	Resistor, Metal Film, 1/8W, 1%, 50PPM
R 404	4-00130-407	1.00K	Resistor, Metal Film, 1/8W, 1%, 50PPM
R 405	4-00703-407	1.43K	Resistor, Metal Film, 1/8W, 1%, 50PPM
R 406	4-00137-407	1.91K	Resistor, Metal Film, 1/8W, 1%, 50PPM
R 407	4-00137-407	1.91K	Resistor, Metal Film, 1/8W, 1%, 50PPM
R 408	4-00296-407	604	Resistor, Metal Film, 1/8W, 1%, 50PPM
R 409	4-00517-407	3.57K	Resistor, Metal Film, 1/8W, 1%, 50PPM
R 410	4-00517-407	3.57K	Resistor, Metal Film, 1/8W, 1%, 50PPM
R 411	4-00180-407	301	Resistor, Metal Film, 1/8W, 1%, 50PPM
R 412	4-00464-407	6.98K	Resistor, Metal Film, 1/8W, 1%, 50PPM
R 413	4-00464-407	6.98K	Resistor, Metal Film, 1/8W, 1%, 50PPM
R 414	4-00875-407	147	Resistor, Metal Film, 1/8W, 1%, 50PPM
R 415	4-00763-407	14.0K	Resistor, Metal Film, 1/8W, 1%, 50PPM
R 416	4-00763-407	14.0K	Resistor, Metal Film, 1/8W, 1%, 50PPM
R 417	4-00176-407	3.01K	Resistor, Metal Film, 1/8W, 1%, 50PPM

R 418	4-00135-407	1.50K	Resistor, Metal Film, 1/8W, 1%, 50PPM
R 419	4-00130-407	1.00K	Resistor, Metal Film, 1/8W, 1%, 50PPM
R 420	4-00176-407	3.01K	Resistor, Metal Film, 1/8W, 1%, 50PPM
R 421	4-00398-407	499K	Resistor, Metal Film, 1/8W, 1%, 50PPM
R 422	4-00130-407	1.00K	Resistor, Metal Film, 1/8W, 1%, 50PPM
R 423	4-00188-407	4.99K	Resistor, Metal Film, 1/8W, 1%, 50PPM
R 424	4-00577-407	1.21K	Resistor, Metal Film, 1/8W, 1%, 50PPM
R 425	4-00577-407	1.21K	Resistor, Metal Film, 1/8W, 1%, 50PPM
R 426	4-00130-407	1.00K	Resistor, Metal Film, 1/8W, 1%, 50PPM
R 427	4-00141-407	100	Resistor, Metal Film, 1/8W, 1%, 50PPM
R 429	4-00193-407	499	Resistor, Metal Film, 1/8W, 1%, 50PPM
R 430	4-00188-407	4.99K	Resistor, Metal Film, 1/8W, 1%, 50PPM
R 501	4-00238-407	464	Resistor, Metal Film, 1/8W, 1%, 50PPM
R 502	4-00180-407	301	Resistor, Metal Film, 1/8W, 1%, 50PPM
R 503	4-00654-407	182	Resistor, Metal Film, 1/8W, 1%, 50PPM
R 504	4-00553-407	2.55K	Resistor, Metal Film, 1/8W, 1%, 50PPM
R 505	4-00655-407	665	Resistor, Metal Film, 1/8W, 1%, 50PPM
R 506	4-00138-407	10.0K	Resistor, Metal Film, 1/8W, 1%, 50PPM
R 507	4-00158-407	2.00K	Resistor, Metal Film, 1/8W, 1%, 50PPM
R 508	4-00557-407	40.2K	Resistor, Metal Film, 1/8W, 1%, 50PPM
R 509	4-00416-407	3.24K	Resistor, Metal Film, 1/8W, 1%, 50PPM
R 510	4-00138-407	10.0K	Resistor, Metal Film, 1/8W, 1%, 50PPM
R 511	4-00347-407	7.50K	Resistor, Metal Film, 1/8W, 1%, 50PPM
R 512	4-00580-407	475	Resistor, Metal Film, 1/8W, 1%, 50PPM
R 513	4-00580-407	475	Resistor, Metal Film, 1/8W, 1%, 50PPM
R 514	4-00154-407	150	Resistor, Metal Film, 1/8W, 1%, 50PPM
R 515	4-00416-407	3.24K	Resistor, Metal Film, 1/8W, 1%, 50PPM
R 516	4-00763-407	14.0K	Resistor, Metal Film, 1/8W, 1%, 50PPM
R 517	4-00519-407	4.75K	Resistor, Metal Film, 1/8W, 1%, 50PPM
R 518	4-00577-407	1.21K	Resistor, Metal Film, 1/8W, 1%, 50PPM
R 519	4-00141-407	100	Resistor, Metal Film, 1/8W, 1%, 50PPM
R 520	4-00141-407	100	Resistor, Metal Film, 1/8W, 1%, 50PPM
R 521	4-00193-407	499	Resistor, Metal Film, 1/8W, 1%, 50PPM
R 522	4-00138-407	10.0K	Resistor, Metal Film, 1/8W, 1%, 50PPM
R 523	4-00141-407	100	Resistor, Metal Film, 1/8W, 1%, 50PPM
R 524	4-00461-407	30.1	Resistor, Metal Film, 1/8W, 1%, 50PPM
R 525	4-00141-407	100	Resistor, Metal Film, 1/8W, 1%, 50PPM
R 526	4-00902-404	43	Resistor, Carbon Comp, 1/4W, 5%
R 527	4-00680-439	10	Resistor, Metal Film, 1/4W, 1%, 50ppm
R 528	4-00680-439	10	Resistor, Metal Film, 1/4W, 1%, 50ppm
R 529	4-00902-404	43	Resistor, Carbon Comp, 1/4W, 5%
R 530	4-00056-401	22	Resistor, Carbon Film, 1/4W, 5%
R 531	4-00239-407	953	Resistor, Metal Film, 1/8W, 1%, 50PPM
R 532	4-00330-407	1.65K	Resistor, Metal Film, 1/8W, 1%, 50PPM
R 533	4-00200-407	619	Resistor, Metal Film, 1/8W, 1%, 50PPM
R 534	4-00553-407	2.55K	Resistor, Metal Film, 1/8W, 1%, 50PPM
R 535	4-00655-407	665	Resistor, Metal Film, 1/8W, 1%, 50PPM
R 536	4-00138-407	10.0K	Resistor, Metal Film, 1/8W, 1%, 50PPM
R 537	4-00158-407	2.00K	Resistor, Metal Film, 1/8W, 1%, 50PPM
R 538	4-00557-407	40.2K	Resistor, Metal Film, 1/8W, 1%, 50PPM
R 539	4-00416-407	3.24K	Resistor, Metal Film, 1/8W, 1%, 50PPM
R 540	4-00138-407	10.0K	Resistor, Metal Film, 1/8W, 1%, 50PPM

## 6-24 Parts List

---

R 541	4-00347-407	7.50K	Resistor, Metal Film, 1/8W, 1%, 50PPM
R 542	4-00580-407	475	Resistor, Metal Film, 1/8W, 1%, 50PPM
R 543	4-00580-407	475	Resistor, Metal Film, 1/8W, 1%, 50PPM
R 544	4-00154-407	150	Resistor, Metal Film, 1/8W, 1%, 50PPM
R 545	4-00416-407	3.24K	Resistor, Metal Film, 1/8W, 1%, 50PPM
R 546	4-00763-407	14.0K	Resistor, Metal Film, 1/8W, 1%, 50PPM
R 547	4-00519-407	4.75K	Resistor, Metal Film, 1/8W, 1%, 50PPM
R 548	4-00577-407	1.21K	Resistor, Metal Film, 1/8W, 1%, 50PPM
R 549	4-00141-407	100	Resistor, Metal Film, 1/8W, 1%, 50PPM
R 550	4-00141-407	100	Resistor, Metal Film, 1/8W, 1%, 50PPM
R 551	4-00193-407	499	Resistor, Metal Film, 1/8W, 1%, 50PPM
R 552	4-00138-407	10.0K	Resistor, Metal Film, 1/8W, 1%, 50PPM
R 553	4-00141-407	100	Resistor, Metal Film, 1/8W, 1%, 50PPM
R 554	4-00461-407	30.1	Resistor, Metal Film, 1/8W, 1%, 50PPM
R 555	4-00141-407	100	Resistor, Metal Film, 1/8W, 1%, 50PPM
R 556	4-00902-404	43	Resistor, Carbon Comp, 1/4W, 5%
R 557	4-00680-439	10	Resistor, Metal Film, 1/4W, 1%, 50ppm
R 558	4-00680-439	10	Resistor, Metal Film, 1/4W, 1%, 50ppm
R 559	4-00902-404	43	Resistor, Carbon Comp, 1/4W, 5%
R 560	4-00056-401	22	Resistor, Carbon Film, 1/4W, 5%
R 564	4-00902-404	43	Resistor, Carbon Comp, 1/4W, 5%
R 565	4-00902-404	43	Resistor, Carbon Comp, 1/4W, 5%
R 566	4-00902-404	43	Resistor, Carbon Comp, 1/4W, 5%
R 567	4-00902-404	43	Resistor, Carbon Comp, 1/4W, 5%
R 568	4-00234-407	10	Resistor, Metal Film, 1/8W, 1%, 50PPM
R 569	4-00886-407	8.45K	Resistor, Metal Film, 1/8W, 1%, 50PPM
R 570	4-00206-407	8.06K	Resistor, Metal Film, 1/8W, 1%, 50PPM
R 571	4-00234-407	10	Resistor, Metal Film, 1/8W, 1%, 50PPM
R 572	4-00234-407	10	Resistor, Metal Film, 1/8W, 1%, 50PPM
R 573	4-00234-407	10	Resistor, Metal Film, 1/8W, 1%, 50PPM
R 574	4-00193-407	499	Resistor, Metal Film, 1/8W, 1%, 50PPM
R 575	4-00193-407	499	Resistor, Metal Film, 1/8W, 1%, 50PPM
R 601	4-00867-439	84.5	Resistor, Metal Film, 1/4W, 1%, 50ppm
R 602	4-00867-439	84.5	Resistor, Metal Film, 1/4W, 1%, 50ppm
R 603	4-00867-439	84.5	Resistor, Metal Film, 1/4W, 1%, 50ppm
R 604	4-00868-439	750	Resistor, Metal Film, 1/4W, 1%, 50ppm
R 605	4-00868-439	750	Resistor, Metal Film, 1/4W, 1%, 50ppm
R 606	4-00868-439	750	Resistor, Metal Film, 1/4W, 1%, 50ppm
R 607	4-00883-407	30.9	Resistor, Metal Film, 1/8W, 1%, 50PPM
R 608	4-00867-439	84.5	Resistor, Metal Film, 1/4W, 1%, 50ppm
R 609	4-00867-439	84.5	Resistor, Metal Film, 1/4W, 1%, 50ppm
R 610	4-00867-439	84.5	Resistor, Metal Film, 1/4W, 1%, 50ppm
R 611	4-00868-439	750	Resistor, Metal Film, 1/4W, 1%, 50ppm
R 612	4-00868-439	750	Resistor, Metal Film, 1/4W, 1%, 50ppm
R 613	4-00868-439	750	Resistor, Metal Film, 1/4W, 1%, 50ppm
R 614	4-00883-407	30.9	Resistor, Metal Film, 1/8W, 1%, 50PPM
R 615	4-00169-407	249	Resistor, Metal Film, 1/8W, 1%, 50PPM
R 616	4-00883-407	30.9	Resistor, Metal Film, 1/8W, 1%, 50PPM
R 617	4-00522-407	243	Resistor, Metal Film, 1/8W, 1%, 50PPM
R 618	4-00490-407	27.4	Resistor, Metal Film, 1/8W, 1%, 50PPM
R 619	4-00169-407	249	Resistor, Metal Film, 1/8W, 1%, 50PPM
R 620	4-00883-407	30.9	Resistor, Metal Film, 1/8W, 1%, 50PPM

R 621	4-00522-407	243	Resistor, Metal Film, 1/8W, 1%, 50PPM
R 622	4-00490-407	27.4	Resistor, Metal Film, 1/8W, 1%, 50PPM
R 623	4-00869-439	54.9	Resistor, Metal Film, 1/4W, 1%, 50ppm
R 624	4-00869-439	54.9	Resistor, Metal Film, 1/4W, 1%, 50ppm
R 625	4-00870-439	549	Resistor, Metal Film, 1/4W, 1%, 50ppm
R 626	4-00870-439	549	Resistor, Metal Film, 1/4W, 1%, 50ppm
R 627	4-00871-439	110	Resistor, Metal Film, 1/4W, 1%, 50ppm
R 628	4-00871-439	110	Resistor, Metal Film, 1/4W, 1%, 50ppm
R 629	4-00872-439	576	Resistor, Metal Film, 1/4W, 1%, 50ppm
R 630	4-00869-439	54.9	Resistor, Metal Film, 1/4W, 1%, 50ppm
R 631	4-00869-439	54.9	Resistor, Metal Film, 1/4W, 1%, 50ppm
R 632	4-00870-439	549	Resistor, Metal Film, 1/4W, 1%, 50ppm
R 633	4-00870-439	549	Resistor, Metal Film, 1/4W, 1%, 50ppm
R 634	4-00871-439	110	Resistor, Metal Film, 1/4W, 1%, 50ppm
R 635	4-00871-439	110	Resistor, Metal Film, 1/4W, 1%, 50ppm
R 636	4-00872-439	576	Resistor, Metal Film, 1/4W, 1%, 50ppm
R 701	4-00141-407	100	Resistor, Metal Film, 1/8W, 1%, 50PPM
R 702	4-00582-407	2.15K	Resistor, Metal Film, 1/8W, 1%, 50PPM
R 703	4-00582-407	2.15K	Resistor, Metal Film, 1/8W, 1%, 50PPM
R 704	4-00141-407	100	Resistor, Metal Film, 1/8W, 1%, 50PPM
R 705	4-00142-407	100K	Resistor, Metal Film, 1/8W, 1%, 50PPM
R 706	4-00785-402	100	Resistor, Carbon Comp, 1/2W, 5%
R 707	4-00345-402	1.5K	Resistor, Carbon Comp, 1/2W, 5%
TP1	1-00143-101	TEST JACK	Vertical Test Jack
TP2	1-00143-101	TEST JACK	Vertical Test Jack
TP3	1-00143-101	TEST JACK	Vertical Test Jack
TP4	1-00143-101	TEST JACK	Vertical Test Jack
TP5	1-00143-101	TEST JACK	Vertical Test Jack
TP6	1-00143-101	TEST JACK	Vertical Test Jack
TP7	1-00143-101	TEST JACK	Vertical Test Jack
TP8	1-00143-101	TEST JACK	Vertical Test Jack
U 101	3-00614-340	HCPL-7710	Integrated Circuit (Thru-hole Pkg)
U 102	3-00614-340	HCPL-7710	Integrated Circuit (Thru-hole Pkg)
U 103	3-00614-340	HCPL-7710	Integrated Circuit (Thru-hole Pkg)
U 106	3-00446-340	6N137	Integrated Circuit (Thru-hole Pkg)
U 107	3-00446-340	6N137	Integrated Circuit (Thru-hole Pkg)
U 108	3-00446-340	6N137	Integrated Circuit (Thru-hole Pkg)
U 109	3-00303-340	74HC164	Integrated Circuit (Thru-hole Pkg)
U 110	3-00303-340	74HC164	Integrated Circuit (Thru-hole Pkg)
U 111	3-00037-340	74HC138	Integrated Circuit (Thru-hole Pkg)
U 112	3-00446-340	6N137	Integrated Circuit (Thru-hole Pkg)
U 113	3-00262-340	74HC86	Integrated Circuit (Thru-hole Pkg)
U 114	3-00614-340	HCPL-7710	Integrated Circuit (Thru-hole Pkg)
U 201	3-00615-340	AD1862N-J	Integrated Circuit (Thru-hole Pkg)
U 202	3-00616-340	AD797AN	Integrated Circuit (Thru-hole Pkg)
U 203	3-00130-340	5532A	Integrated Circuit (Thru-hole Pkg)
U 204	3-00130-340	5532A	Integrated Circuit (Thru-hole Pkg)
U 205	3-00130-340	5532A	Integrated Circuit (Thru-hole Pkg)
U 206	3-00423-340	5534A	Integrated Circuit (Thru-hole Pkg)
U 207	3-00089-340	LF357	Integrated Circuit (Thru-hole Pkg)
U 208	3-00091-340	LF412	Integrated Circuit (Thru-hole Pkg)
U 209	3-00211-340	LT1016	Integrated Circuit (Thru-hole Pkg)

## 6-26 Parts List

---

U 210	3-00094-340	LM311	Integrated Circuit (Thru-hole Pkg)
U 301	3-00423-340	5534A	Integrated Circuit (Thru-hole Pkg)
U 302	3-00423-340	5534A	Integrated Circuit (Thru-hole Pkg)
U 303	3-00423-340	5534A	Integrated Circuit (Thru-hole Pkg)
U 304	3-00423-340	5534A	Integrated Circuit (Thru-hole Pkg)
U 305	3-00423-340	5534A	Integrated Circuit (Thru-hole Pkg)
U 306	3-00423-340	5534A	Integrated Circuit (Thru-hole Pkg)
U 308	3-00616-340	AD797AN	Integrated Circuit (Thru-hole Pkg)
U 309	3-00411-340	74HC273	Integrated Circuit (Thru-hole Pkg)
U 401	3-00618-340	AD7549JN	Integrated Circuit (Thru-hole Pkg)
U 402	3-00394-340	OP275	Integrated Circuit (Thru-hole Pkg)
U 403	3-00394-340	OP275	Integrated Circuit (Thru-hole Pkg)
U 404	3-00371-340	DG444	Integrated Circuit (Thru-hole Pkg)
U 405	3-00619-340	REF02	Integrated Circuit (Thru-hole Pkg)
U 406	3-00059-340	7542	Integrated Circuit (Thru-hole Pkg)
U 407	3-00130-340	5532A	Integrated Circuit (Thru-hole Pkg)
U 408	3-00616-340	AD797AN	Integrated Circuit (Thru-hole Pkg)
U 501	3-00616-340	AD797AN	Integrated Circuit (Thru-hole Pkg)
U 502	3-00423-340	5534A	Integrated Circuit (Thru-hole Pkg)
U 503	3-00231-328	MAT02-EH	Transistor, TO-78 Package
U 504	3-00616-340	AD797AN	Integrated Circuit (Thru-hole Pkg)
U 505	3-00423-340	5534A	Integrated Circuit (Thru-hole Pkg)
U 506	3-00231-328	MAT02-EH	Transistor, TO-78 Package
U 601	3-00411-340	74HC273	Integrated Circuit (Thru-hole Pkg)
U 602	3-00195-340	CA3082	Integrated Circuit (Thru-hole Pkg)
U 603	3-00411-340	74HC273	Integrated Circuit (Thru-hole Pkg)
U 604	3-00195-340	CA3082	Integrated Circuit (Thru-hole Pkg)
U 605	3-00195-340	CA3082	Integrated Circuit (Thru-hole Pkg)
U 606	3-00411-340	74HC273	Integrated Circuit (Thru-hole Pkg)
U 607	3-00195-340	CA3082	Integrated Circuit (Thru-hole Pkg)
U 608	3-00411-340	74HC273	Integrated Circuit (Thru-hole Pkg)
U 609	3-00195-340	CA3082	Integrated Circuit (Thru-hole Pkg)
U 610	3-00411-340	74HC273	Integrated Circuit (Thru-hole Pkg)
U 706	3-00117-325	78L12	Transistor, TO-92 Package
U 707	3-00122-325	79L05	Transistor, TO-92 Package
U 708	3-00123-325	79L12	Transistor, TO-92 Package
Z 0	0-00163-007	TO-5	Heat Sinks
Z 0	0-00165-003	TO-18	Insulators
Z 0	0-00612-003	TO5 PLASTIC	Insulators
Z 0	0-00772-000	1.5" WIRE	Hardware, Misc.

## Front Panel Parts List

This section covers schematics FP-1 through FP-2.

Front Panel Assembly			
Ref No.	Ref No.	Ref No.	Ref No.
C 1	5-00219-529	.01U	Cap, Monolythic Ceramic, 50V, 20%, Z5U
C 2	5-00022-501	.001U	Capacitor, Ceramic Disc, 50V, 10%, SL
C 3	5-00219-529	.01U	Cap, Monolythic Ceramic, 50V, 20%, Z5U
C 4	5-00022-501	.001U	Capacitor, Ceramic Disc, 50V, 10%, SL
C 5	5-00023-529	.1U	Cap, Monolythic Ceramic, 50V, 20%, Z5U
C 6	5-00022-501	.001U	Capacitor, Ceramic Disc, 50V, 10%, SL
C 7	5-00041-509	220U	Capacitor, Electrolytic, 50V, 20%, Rad
C 8	5-00041-509	220U	Capacitor, Electrolytic, 50V, 20%, Rad
C 9	5-00219-529	.01U	Cap, Monolythic Ceramic, 50V, 20%, Z5U
C 10	5-00002-501	100P	Capacitor, Ceramic Disc, 50V, 10%, SL
C 11	5-00002-501	100P	Capacitor, Ceramic Disc, 50V, 10%, SL
C 12	5-00002-501	100P	Capacitor, Ceramic Disc, 50V, 10%, SL
C 13	5-00002-501	100P	Capacitor, Ceramic Disc, 50V, 10%, SL
D 101	3-00012-306	GREEN	LED, Rectangular
D 102	3-00012-306	GREEN	LED, Rectangular
D 103	3-00012-306	GREEN	LED, Rectangular
D 104	3-00012-306	GREEN	LED, Rectangular
D 105	3-00012-306	GREEN	LED, Rectangular
D 106	3-00012-306	GREEN	LED, Rectangular
D 108	3-00012-306	GREEN	LED, Rectangular
D 109	3-00012-306	GREEN	LED, Rectangular
D 110	3-00012-306	GREEN	LED, Rectangular
D 111	3-00012-306	GREEN	LED, Rectangular
D 112	3-00012-306	GREEN	LED, Rectangular
D 113	3-00012-306	GREEN	LED, Rectangular
D 114	3-00012-306	GREEN	LED, Rectangular
D 115	3-00012-306	GREEN	LED, Rectangular
D 116	3-00012-306	GREEN	LED, Rectangular
D 117	3-00012-306	GREEN	LED, Rectangular
D 118	3-00012-306	GREEN	LED, Rectangular
D 121	3-00012-306	GREEN	LED, Rectangular
D 122	3-00012-306	GREEN	LED, Rectangular
D 123	3-00012-306	GREEN	LED, Rectangular
D 124	3-00012-306	GREEN	LED, Rectangular
D 125	3-00012-306	GREEN	LED, Rectangular
D 126	3-00547-310	RED COATED	LED, Coated Rectangular
D 127	3-00547-310	RED COATED	LED, Coated Rectangular
D 129	3-00012-306	GREEN	LED, Rectangular
D 130	3-00012-306	GREEN	LED, Rectangular
D 131	3-00012-306	GREEN	LED, Rectangular
D 132	3-00012-306	GREEN	LED, Rectangular
D 133	3-00012-306	GREEN	LED, Rectangular
D 134	3-00012-306	GREEN	LED, Rectangular
D 136	3-00012-306	GREEN	LED, Rectangular
D 137	3-00012-306	GREEN	LED, Rectangular

## 6-28 Parts List

D 138	3-00012-306	GREEN	LED, Rectangular
D 139	3-00012-306	GREEN	LED, Rectangular
D 140	3-00012-306	GREEN	LED, Rectangular
D 141	3-00012-306	GREEN	LED, Rectangular
D 142	3-00012-306	GREEN	LED, Rectangular
D 143	3-00547-310	RED COATED	LED, Coated Rectangular
D 144	3-00547-310	RED COATED	LED, Coated Rectangular
D 145	3-00012-306	GREEN	LED, Rectangular
D 146	3-00012-306	GREEN	LED, Rectangular
D 148	3-00547-310	RED COATED	LED, Coated Rectangular
D 149	3-00547-310	RED COATED	LED, Coated Rectangular
D 150	3-00547-310	RED COATED	LED, Coated Rectangular
D 151	3-00547-310	RED COATED	LED, Coated Rectangular
D 152	3-00547-310	RED COATED	LED, Coated Rectangular
D 153	3-00547-310	RED COATED	LED, Coated Rectangular
D 154	3-00547-310	RED COATED	LED, Coated Rectangular
D 155	3-00547-310	RED COATED	LED, Coated Rectangular
D 156	3-00547-310	RED COATED	LED, Coated Rectangular
D 160	3-00004-301	1N4148	Diode
D 161	3-00004-301	1N4148	Diode
D 162	3-00004-301	1N4148	Diode
D 163	3-00004-301	1N4148	Diode
D 164	3-00004-301	1N4148	Diode
D 165	3-00004-301	1N4148	Diode
D 166	3-00004-301	1N4148	Diode
D 167	3-00004-301	1N4148	Diode
J 3	1-00073-120	INSL	Connector, BNC
J 4	1-00073-120	INSL	Connector, BNC
J 5	0-00322-035	RED	BANANA JACK
J 6	0-00324-035	WHITE	BANANA JACK
J 7	0-00321-035	BLACK	BANANA JACK
J 8	0-00323-035	GREEN	BANANA JACK
J 12	1-00073-120	INSL	Connector, BNC
J 13	1-00073-120	INSL	Connector, BNC
J 101	1-00171-130	34 PIN ELH	Connector, Male
J 102	1-00138-130	5 PIN SI	Connector, Male
PC1	7-00578-701	DS360 FP	Printed Circuit Board
PC2	7-00698-701	DS360 OUTPUT	Printed Circuit Board
R 1	4-00142-407	100K	Resistor, Metal Film, 1/8W, 1%, 50PPM
T 702	1-00259-113	4 PIN, 18AWG/OR Connector, Amp, MTA-156	
U 101	3-00288-340	HDSP-H101	Integrated Circuit (Thru-hole Pkg)
U 102	3-00288-340	HDSP-H101	Integrated Circuit (Thru-hole Pkg)
U 103	3-00288-340	HDSP-H101	Integrated Circuit (Thru-hole Pkg)
U 104	3-00288-340	HDSP-H101	Integrated Circuit (Thru-hole Pkg)
U 105	3-00288-340	HDSP-H101	Integrated Circuit (Thru-hole Pkg)
U 106	3-00288-340	HDSP-H101	Integrated Circuit (Thru-hole Pkg)
U 107	3-00288-340	HDSP-H101	Integrated Circuit (Thru-hole Pkg)
U 108	3-00288-340	HDSP-H101	Integrated Circuit (Thru-hole Pkg)
Z 0	0-00011-057	GROMMET	Grommet
Z 0	0-00017-002	TRANSCOVER	Power Entry Hardware
Z 0	0-00025-005	3/8"	Lugs
Z 0	0-00045-013	4-40 MINI	Nut, Mini



Z 0	0-00048-011	6-32 KEP	Nut, Kep
Z 0	0-00079-031	4-40X3/16 M/F	Standoff
Z 0	0-00089-033	4"	Tie
Z 0	0-00101-040	1/4X1/32	Washer, Flat
Z 0	0-00104-043	#4 NYLON	Washer, nylon
Z 0	0-00111-053	1-3/4"#24B	Wire #24 UL1007 Strip 1/4x1/4 Tin
Z 0	0-00122-053	2-1/4" #24	Wire #24 UL1007 Strip 1/4x1/4 Tin
Z 0	0-00133-052	7-1/2" #22	Wire #22 UL1007
Z 0	0-00149-020	4-40X1/4PF	Screw, Flathead Phillips
Z 0	0-00153-057	GROMMET2	Grommet
Z 0	0-00181-020	6-32X1/4PF	Screw, Flathead Phillips
Z 0	0-00186-021	6-32X1-3/8PP	screw, Panhead Phillips
Z 0	0-00187-021	4-40X1/4PP	Screw, Panhead Phillips
Z 0	0-00190-030	#8X1"	Spacer
Z 0	0-00209-021	4-40X3/8PP	Screw, Panhead Phillips
Z 0	0-00211-020	4-40X5/8PF	Screw, Flathead Phillips
Z 0	0-00231-043	1-32, #4 SHOULD	Washer, nylon
Z 0	0-00237-016	F1404	Power Button
Z 0	0-00243-003	TO-220	Insulators
Z 0	0-00249-021	6-32X1-1/2PP	Screw, Panhead Phillips
Z 0	0-00256-043	#6 SHOULD	Washer, nylon
Z 0	0-00266-052	8-1/2" #22 BLK	Wire #22 UL1007
Z 0	0-00270-052	7-3/4" #22 BLUE	Wire #22 UL1007
Z 0	0-00314-040	#8 18-8 SS	Washer, Flat
Z 0	0-00407-032	SOLDR SLV RG174	Termination
Z 0	0-00439-052	8-1/2" #22 RED	Wire #22 UL1007
Z 0	0-00472-018	1-329631-2	Jam Nut
Z 0	0-00487-004	SR810/DS360	Knobs
Z 0	0-00488-004	CAP - SR810	Knobs
Z 0	0-00495-021	4-40X11/16PP	Screw, Panhead Phillips
Z 0	0-00500-000	554808-1	Hardware, Misc.
Z 0	0-00501-042	1-329632-2	Washer, lock
Z 0	0-00517-000	BINDING POST	Hardware, Misc.
Z 0	0-00523-048	5-5/8" #18	Wire, #18 UL1015 Strip 3/8 x 3/8 No Tin
Z 0	0-00534-070	40MM 12V THIN	Fans, & Hardware
Z 0	0-00535-030	1/2" X 3/16"RND	Spacer
Z 0	0-00536-032	31894	Termination
Z 0	0-00539-048	21-1/2" #18	Wire, #18 UL1015 Strip 3/8 x 3/8 No Tin
Z 0	0-00542-042	1/4" INTERNAL	Washer, lock
Z 0	0-00543-010	1/4-32 PANEL	Nut, Hex
Z 0	0-00545-000	CABLE	Hardware, Misc.
Z 0	0-00615-066	OC97-0540-02	Copper Foil Tape, Self Adhesive
Z 0	0-00987-002	6EDL4CM	Power Entry Hardware
Z 0	1-00031-133	16 PIN SRA	Connector, Male, Right Angle
Z 0	1-00033-113	5 PIN, 18AWG/OR	Connector, Amp, MTA-156
Z 0	1-00141-171	5 PIN SIL	Cable Assembly, Ribbon
Z 0	1-00255-100	XLR MALE	Connector, Misc.
Z 0	1-00256-171	8 COND SIL	Cable Assembly, Ribbon
Z 0	1-00257-171	10 COND SIL	Cable Assembly, Ribbon
Z 0	1-00258-171	34 COND DIL	Cable Assembly, Ribbon
Z 0	2-00034-220	ENA1J-B20	SOFTPOT
Z 0	4-01641-431	YM120, 260V	Thermistor, various

**6-30 Parts List**

---

Z 0	6-00119-614	FT82-77	Iron Powder Core
Z 0	6-00165-610	DS360	Transformer
Z 0	6-00212-630	1"X.25"CYL	Ferrite Beads
Z 0	6-00574-611	.25A TIME LAG	Fuse
Z 0	6-00575-611	.5A TIME LAG	Fuse
Z 0	7-00565-720	DS360	Fabricated Part
Z 0	7-00566-720	DS360-6	Fabricated Part
Z 0	7-00567-720	DS360-7	Fabricated Part
Z 0	7-00568-709	DS360-8	Lexan Overlay
Z 0	7-00569-709	DS360-9	Lexan Overlay
Z 0	7-00570-740	DS360-10	Keypad, Conductive Rubber
Z 0	7-00584-721	DS360-12	Machined Part
Z 0	7-00646-720	DS360-17	Fabricated Part
Z 0	7-01256-720	WIRE/PWR SHLD	Fabricated Part
Z 0	9-00267-917	GENERIC	Product Labels
Z 0	9-01516-917	DS360-SERRATO	Product Labels
Z 0	9-01518-917	DS360 - 220V	Product Labels

## Distortion Filter Parts List

This section covers schematics PROGR-1.

Distortion Filter Assembly			
Ref No.	Ref No.	Ref No.	Ref No.
C 1A	5-00298-568	.01U	Cap, Ceramic 50V SMT (1206) +/-10% X7R
C 1B	5-00298-568	.01U	Cap, Ceramic 50V SMT (1206) +/-10% X7R
C 2A	5-00298-568	.01U	Cap, Ceramic 50V SMT (1206) +/-10% X7R
C 2B	5-00298-568	.01U	Cap, Ceramic 50V SMT (1206) +/-10% X7R
C 3A	5-00298-568	.01U	Cap, Ceramic 50V SMT (1206) +/-10% X7R
C 3B	5-00298-568	.01U	Cap, Ceramic 50V SMT (1206) +/-10% X7R
J 1	1-00031-133	16 PIN SRA	Connector, Male, Right Angle
J 1A	1-00031-133	16 PIN SRA	Connector, Male, Right Angle
PC3	7-00701-701	DS360 RESISTOR	Printed Circuit Board
PC4	7-00701-701	DS360 RESISTOR	Printed Circuit Board
R 1A	4-00716-407	1.40K	Resistor, Metal Film, 1/8W, 1%, 50PPM
R 1B	4-00716-407	1.40K	Resistor, Metal Film, 1/8W, 1%, 50PPM
R 2A	4-00136-407	1.82K	Resistor, Metal Film, 1/8W, 1%, 50PPM
R 2B	4-00136-407	1.82K	Resistor, Metal Film, 1/8W, 1%, 50PPM
R 3A	4-00351-407	2.32K	Resistor, Metal Film, 1/8W, 1%, 50PPM
R 3B	4-00351-407	2.32K	Resistor, Metal Film, 1/8W, 1%, 50PPM
R 4A	4-00176-407	3.01K	Resistor, Metal Film, 1/8W, 1%, 50PPM
R 4B	4-00176-407	3.01K	Resistor, Metal Film, 1/8W, 1%, 50PPM
R 5A	4-00607-407	3.92K	Resistor, Metal Film, 1/8W, 1%, 50PPM
R 5B	4-00607-407	3.92K	Resistor, Metal Film, 1/8W, 1%, 50PPM
R 6A	4-00194-407	5.11K	Resistor, Metal Film, 1/8W, 1%, 50PPM
R 6B	4-00194-407	5.11K	Resistor, Metal Film, 1/8W, 1%, 50PPM
R 7A	4-00716-407	1.40K	Resistor, Metal Film, 1/8W, 1%, 50PPM
R 7B	4-00716-407	1.40K	Resistor, Metal Film, 1/8W, 1%, 50PPM
R 8A	4-00136-407	1.82K	Resistor, Metal Film, 1/8W, 1%, 50PPM
R 8B	4-00136-407	1.82K	Resistor, Metal Film, 1/8W, 1%, 50PPM
R 9A	4-00351-407	2.32K	Resistor, Metal Film, 1/8W, 1%, 50PPM
R 9B	4-00351-407	2.32K	Resistor, Metal Film, 1/8W, 1%, 50PPM
R 10A	4-00176-407	3.01K	Resistor, Metal Film, 1/8W, 1%, 50PPM
R 10B	4-00176-407	3.01K	Resistor, Metal Film, 1/8W, 1%, 50PPM
R 11A	4-00607-407	3.92K	Resistor, Metal Film, 1/8W, 1%, 50PPM
R 11B	4-00607-407	3.92K	Resistor, Metal Film, 1/8W, 1%, 50PPM
R 12A	4-00194-407	5.11K	Resistor, Metal Film, 1/8W, 1%, 50PPM
R 12B	4-00194-407	5.11K	Resistor, Metal Film, 1/8W, 1%, 50PPM
U 1A	3-00643-360	DG211BDY	Integrated Circuit (Surface Mount Pkg)
U 1B	3-00643-360	DG211BDY	Integrated Circuit (Surface Mount Pkg)
U 2A	3-00643-360	DG211BDY	Integrated Circuit (Surface Mount Pkg)
U 2B	3-00643-360	DG211BDY	Integrated Circuit (Surface Mount Pkg)
U 3A	3-00643-360	DG211BDY	Integrated Circuit (Surface Mount Pkg)
U 3B	3-00643-360	DG211BDY	Integrated Circuit (Surface Mount Pkg)
U 4A	3-00643-360	DG211BDY	Integrated Circuit (Surface Mount Pkg)
U 4B	3-00643-360	DG211BDY	Integrated Circuit (Surface Mount Pkg)

## Miscellaneous and Chassis Parts List

Miscellaneous and Chassis Assembly			
Ref No.	Ref No.	Ref No.	Ref No.
U 402	3-00345-342	27C512-120	EPROM/PROM, I.C.
Z 0	0-00149-020	4-40X1/4PF	Screw, Flathead Phillips
Z 0	0-00179-000	RIGHT FOOT	Hardware, Misc.
Z 0	0-00180-000	LEFT FOOT	Hardware, Misc.
Z 0	0-00185-021	6-32X3/8PP	Screw, Panhead Phillips
Z 0	0-00187-021	4-40X1/4PP	Screw, Panhead Phillips
Z 0	0-00204-000	REAR FOOT	Hardware, Misc.
Z 0	0-00248-026	10-32X3/8TRUSSP	Screw, Black, All Types
Z 0	0-00315-021	6-32X7/16 PP	Screw, Panhead Phillips
Z 0	0-00544-057	GROMMET STRIP	Grommet
Z 0	0-00590-066	CU TAPE SWTH	Copper Foil Tape, Self Adhesive
Z 0	1-00583-120	CAP W/O CHAIN	Connector, BNC
Z 0	7-00147-720	BAIL	Fabricated Part
Z 0	7-00562-735	DS360	Injection Molded Plastic
Z 0	7-00563-720	DS360-3	Fabricated Part
Z 0	7-00564-720	DS360-4	Fabricated Part
Z 0	7-00642-720	DS360-13	Fabricated Part
Z 0	7-00643-720	DS360-14	Fabricated Part
Z 0	7-00644-720	DS360-15	Fabricated Part
Z 0	7-00645-720	DS360-16	Fabricated Part